

SMX-C10RN/SMX-C10LN/SMX-C10GN
SMX-C13RN/SMX-C13LN/SMX-C13GN
SMX-C14RN/SMX-C14LN/SMX-C14GN
SMX-C100RN/SMX-C100LN/SMX-C100GN

Memory Camcorder user manual



imagine the possibilities

Thank you for purchasing this Samsung product.
To receive more complete service, please
register your product at
www.samsung.com/register

SAMSUNG

key features of your memory camcorder

High-resolution Color Widescreen LCD (2.7" WIDE TFT LCD)

Samsung memory camcorder utilizes a 2.7-inch 230k pixel Widescreen LCD which allows bright and clear monitoring. In addition, the LCD Enhancer adjusts color and brightness to the screen lighting conditions for better monitoring under strong sunlight.

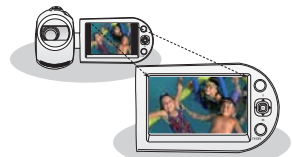

H.264/AVC (MPEG4 part 10/Advanced Video Coding) Encoding

latest video compression technology, H.264, uses a high compression rate to sharply increase the recordable time with the same size storage.

Simple & Easy User Interface

Designed to provide optimized and easy use with an ergonomic design. An improved Graphics User Interface offers a new and fresh look as well as an easy operation.

High-capacity embedded Flash Memory (8GB (SMX-C13 only), 16GB (SMX-C14 only))

The camcorder has a built-in high capacity flash memory that allows you to record movie (or photo) images.

User-friendly Functions

User-friendly EASY Q optimises your memory camcorder to the recording conditions automatically, providing beginners with the best performance.

Twice the memory options (8GB (SMX-C13 only), 16GB (SMX-C14 only))

The memory camcorder's external memory slot accepts both high capacity SDHC and MMCplus cards. Play and transfer videos quickly and easily using the memory type of your choice. In addition to this slot, the memory camcorder has built-in flash memory.

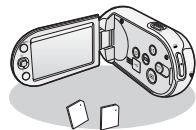

High-resolution image through Mobile DNIe

The Samsung memory camcorder has 3DNR (3-dimensional noise reduction), high-sensitivity color expression (intelligent color expression), High performance Anti-Shake (Hyper DIS), and automatic face detection (Face Detection) features.

Capture Visions farther than the eye can see (10x Optical/1200x Digital Zoom)

Samsung's powerful optical zoom lenses bring the world closer without losing image quality. In addition, Digital Zoom Interpolation enables clearer digital zooming, with less distortion than previous types of digital zooms.



Various Recording Features

The memory camcorder supports Anti-Shake (HDIS), Digital Effect and a wide range of other functions that you can select according to the scene you are recording. ➡pages 56~70

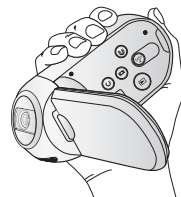

Capturing Photo Image (8GB (SMX-C13 only), 16GB (SMX-C14 only))

Captures a moving subject instantly and saves the scene as a photo image.

Comfortable, Ergonomic Design

This camcorder is designed for comfort when making long recordings. With this ergonomic design, you can shoot subjects comfortably from any position.

Time Lapse Recording Catches the Moment

You can record a long scene in short intervals. Record artistic, documentary videos including the passage of clouds, blooming flowers etc. Use this function to make UCC (user created contents) videos, educational programs or for other purposes.

Direct upload of your videos to the Web!

The built-in editing software Intelli-studio installs directly from this camcorder to your PC, when you simply connect your camcorder to a PC via USB cable. Intelli-studio also allows direct uploading of your contents to YouTube or Flickr with the press of a button. Sharing the contents with your friends is simpler than ever before.

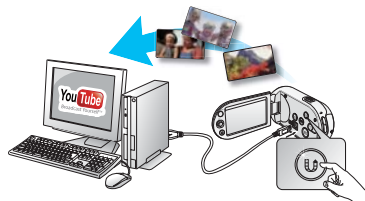





Make a digest of your movie! Storyboard printing!

This function captures 16 still images arbitrarily from the selected movie and saves them into the storage media. It presents a quick overview of your movie, helping you to understand the overall topic.



safety warnings

What the icons and signs in this user manual mean :

 WARNING	Death or risk of serious personal injury.
 CAUTION	Potential risk of personal injury or material damage.
 CAUTION	To reduce the risk of fire, explosion, electric shock, or personal injury when using your camcorder, follow these basic safety precautions:
	Hints or referential pages that may be helpful when operating the camcorder.

These warning signs are here to prevent injury to you and others.

Please follow them explicitly. After reading this section, keep it in a safe place for future reference.

precautions

Warning!

- This camcorder should always be connected to an AC outlet with a protective grounding connection.
- Batteries should not be exposed to excessive heat such as sunshine, fire or similar.

Caution

Danger of explosion if battery is incorrectly replaced.
Replace only with the same or equivalent type.

If this power supply is used at 240V ac, a suitable plug adaptor should be used.

BEFORE USING THIS CAMCORDER

- **This camcorder is designed exclusively for use with the high-capacity built-in flash memory (8GB (SMX-C13 only), (16GB (SMX-C14 only)) and an external memory card.**
- **This camcorder records video in H.264/AVC (MPEG4 part 10/Advanced Video Coding) format compliant with the Standard resolution (SD-VIDEO) format.**
- **Please note that this camcorder is not compatible with other digital video formats.**
- **Before recording important video, make a trial recording.**
 - Play back your trial recording to make sure the video and audio have been recorded properly.
- **The recorded contents cannot be compensated for:**
 - Samsung cannot compensate for any damages caused when recording is not made normally or recorded contents cannot be played back because of a defect in the camcorder or memory card. Also, Samsung cannot be held responsible for your recorded video and audio.
 - Recorded contents may be lost due to an error when handling this camcorder or memory card, etc. Samsung shall not be held responsible for the loss of recorded contents, and cannot compensate for any damages.
- **Make a backup of important recorded data.**
 - Protect your important recorded data by copying the files to a PC. We recommend copying the data to your PC or other recording media for storage. Refer to the software installation and USB connection guide.
- **Copyright: Please note that this camcorder is intended for consumer use only.**
 - Data recorded on a card in this camcorder from other digital/analog media or devices is protected by the copyright act and cannot be used without permission of the copyright owner except for personal enjoyment. Even if you record an event such as a show, performance or exhibition for personal enjoyment, it is strongly recommended that you obtain permission beforehand.

important safety instructions



CAUTION: TO REDUCE THE RISK OF ELECTRIC SHOCK, DO NOT REMOVE COVER (OR BACK). NO USER-SERVICEABLE PARTS INSIDE. REFER SERVICING TO QUALIFIED SERVICE PERSONNEL.



This symbol indicates that dangerous voltage consisting a risk of electric shock is present within this unit.



This symbol indicates that there are important operating and maintenance instructions in the literature accompanying this unit.

Warning

To Reduce The Risk Of Fire Or Electric Shock, Do Not Expose This Apparatus To Rain Or Moisture.

Caution

Apparatus shall not be exposed to dripping or splashing and no objects filled with liquids, such as vases, shall be placed on the apparatus. To disconnect the apparatus from the mains, the plug must be pulled out from the mains socket, therefore the mains plug shall be readily operable.

1. Read these instructions.
2. Keep these instructions.
3. Heed all warnings.
4. Follow all instructions.
5. Do not use this apparatus near water.
6. Clean only with dry cloth.
7. Do not block any ventilation openings. Install in accordance with the manufacturer's instructions.
8. Do not install near any heat sources such as radiators, heat registers, stoves, or other apparatus (including amplifiers) that produce heat.
9. Do not defeat the safety purpose of the polarized or grounding-type plug. A polarized plug has two blades with one wider than the other. A grounding type plug has two blades and a third grounding prong. The wide blade or the third prong are provided for your safety. If the provided plug does not fit into your outlet, consult an electrician for replacement of the obsolete outlet.
10. Protect the power cord from being walked on or pinched particularly at plugs, convenience receptacles, and the point where they exit from the apparatus.
11. Only use attachment/accessories specified by the manufacturer.
12. Use only with the cart, stand, tripod, bracket, or table specified by the manufacturer, or sold with the apparatus. When a cart is used, use caution when moving the cart/apparatus combination to avoid injury from tipping over.
13. Unplug this apparatus during lightning storms or when unused for long periods of time.
14. Refer all servicing to qualified service personnel. Servicing is required when the apparatus has been damaged in any way, such as power-supply cord or plug is damaged, liquid has been spilled or objects have fallen into the apparatus, the apparatus has been exposed to rain or moisture, does not operate normally, or has been dropped.



important safety instructions

22. POWER LINES:

An outside antenna system should not be located in the vicinity of overhead power lines or other electric light or power circuits where it can fall into such power lines or circuits. When installing an outside antenna system, extreme care should be taken to keep from touching such power lines or circuits as contact with them might be fatal.

23. OVERLOADING:

Do not overload wall outlets and extension cords as this can result in a risk of fire or electric shock.

24. OBJECTS AND LIQUIDS:

Never push objects of any kind into this CAMCORDER through openings as they may touch dangerous voltage points or short out a part that could result in a fire or electric shock. Never spill liquids of any kind onto the CAMCORDER. Should spillage occur, unplug unit and have it checked by a technician before use.

25. SERVICING:

Do not attempt to service this CAMCORDER yourself. Opening or removing covers may expose you to dangerous voltage or other hazards. Refer all servicing to qualified service personnel.

26. DAMAGE REQUIRING SERVICE:

Unplug this CAMCORDER from the wall outlet and refer servicing to qualified service personnel under the following conditions:

- a.** When the power-supply cord or plug is damaged.
- b.** If any liquid has been spilled onto, or objects have fallen into the CAMCORDER.
- c.** If the CAMCORDER has been exposed to rain or water.
- d.** If the CAMCORDER does not operate normally by following the operating instructions, adjust only those controls that are covered by the operating instructions. Improper adjustment of other controls may result in damage and will often require extensive work by a qualified technician to restore the CAMCORDER to its normal operation.
- e.** If the CAMCORDER has been dropped or the cabinet has been damaged.
- f.** When the CAMCORDER exhibits a distinct change in performance, this indicates a need for service.

27. REPLACEMENT PARTS:

When replacement parts are required, be sure the service technician has used replacement parts specified by the manufacturer and has the same characteristics as the original part. Unauthorized substitutions may result in fire, electric shock or other hazards.

28. SAFETY CHECK:

Upon completion of any service or repairs to this CAMCORDER, ask the service technician to perform safety checks to determine that the CAMCORDER is in safe operating order.

29. To prevent damage which may result in fire or shock hazard, do not expose this appliance to rain or moisture.
30. If this power supply is used at 240V ac, a suitable plug adaptor should be used.
31. This product is covered by one or more of the following U.S. patents:
 5,060,220 5,457,669 5,561,649 5,705,762 5,987,417
 6,043,912 6,222,983 6,272,096 6,377,524 6,377,531
 6,385,587 6,389,570 6,408,408 6,466,532 6,473,736
 6,477,501 6,480,829 6,556,520 6,556,521 6,556,522
 6,578,163 6,594,208 6,631,110 6,658,588 6,674,697
 6,674,957 6,687,455 6,697,307 6,707,985 6,721,243
 6,721,493 6,728,474 6,741,535 6,744,713 6,744,972
 6,765,853 6,765,853 6,771,890 6,771,891 6,775,465
 6,778,755 6,788,629 6,788,630 6,795,637 6,810,201
 6,862,256 6,868,054 6,894,963 6,937,552

USER INSTALLER CAUTION:

Your authority to operate this FCC certified equipment could be voided if you make changes or modifications not expressly approved by this party responsible for compliance to part 15 FCC rules.

NOTE:

 LAMP(S) INSIDE THIS PRODUCT CONTAIN MERCURY AND MUST BE RECYCLED OR DISPOSED OF ACCORDING TO LOCAL, STATE OR FEDERAL LAWS. For details see lamprecycle.org, eiae.org, or call 1-800-Samsung (7267864)

CALIFORNIA USA ONLY

This Perchlorate warning applies only to primary CR (Manganese Dioxide) Lithium coin cells in the product sold or distributed ONLY in California USA
 “ Perchlorate Material - special handling may apply,
 See [NOTE: This equipment has been tested and found to comply with the limits for a Class B digital device, pursuant to part 15 of the FCC Rules.](http://www.dtsc.ca.gov/hazardouswaste/perchlorate.”</p>
</div>
<div data-bbox=)

These limits are designed to provide reasonable protection against harmful interference in a residential installation. This equipment generates, uses and can radiate radio frequency energy and, if not installed and used in accordance with the instructions, may cause harmful interference to radio communications. However, there is no guarantee that interference will not occur in a particular installation. If this equipment does cause harmful interference to radio or television reception, which can be determined by turning the equipment off and on, the user is encouraged to try to correct the interference by one or more of the following measures:

- Reorient or relocate the receiving antenna.
- Increase the separation between the equipment and receiver.
- Connect the equipment into an outlet on a circuit different from that to which the receiver is connected.
- Consult the dealer or an experienced radio/TV technician for help and for additional suggestions. The user may find the following booklet prepared by the Federal Communications Commission helpful: “How to Identify and Resolve Radio-TV Interference Problems.” This Booklet is available from the U.S. Government Printing Office, Washington, D.C. 20402, Stock No. 004-000-00345-4.

FCC Warning

The user is cautioned that changes or modifications not expressly approved by the manufacturer could void the user’s authority to operate the equipment.

This device complies with Part 15 of FCC Rules.

Operation is subject to the following two conditions;

- (1) This device may not cause harmful interference, and
- (2) This device must accept any interference received, including interference that may cause undesired operation.

important information on use

IMPORTANT NOTE

- **Handle the liquid crystal display (LCD) with care:**

- The LCD is a very delicate display device: Do not press its surface with excessive force, hit it or prick it with a sharp object.
- If you push the LCD surface, display unevenness may occur. If unevenness does not disappear, turn the camcorder off, wait for a few moments, and then turn it on again.
- Do not place the camcorder with the open LCD screen down.
- Close the LCD monitor when not using the camcorder.

- **Liquid crystal display:**

- The LCD screen is a product of high precision technology. Out of the total pixels (approx. 230,000 pixels of an LCD monitor), 0.01% or less pixels may be out (black dots) or may remain lit as colored dots (red, blue, and green). This shows the limitations of the current technology, and does not indicate a fault that will interfere with recording.
- The LCD screen will be slightly dimmer than usual when the camcorder is at low temperature, as in cold areas, or right after the power is turned on. Normal brightness will be restored when the temperature inside the camcorder rises. Note that this will have no effect on the image in a storage media, so there is no cause for concern.

- **Hold the camcorder correctly:**

- Do not hold the camcorder by the LCD monitor when lifting it: the LCD monitor could detach and the camcorder may fall.

- **Do not subject the camcorder to impact:**

- This camcorder is a precision machine. Take great care that you do not strike it against a hard object or let it fall.
- Do not use the camcorder on a tripod in a place where it is subject to severe vibrations or impact.

- **No sand or dust!**

- Fine sand or dust entering the camcorder or AC power adaptor could cause malfunctions or defects.

- **No water or oil!**

- Water or oil entering the camcorder or AC power adaptor could cause electric shock, malfunctions or defects.

- **Heat on surface of product:**

- The surface of the camcorder will be slightly warm when used, but this does not indicate a fault.

- **Be careful of unusual ambient temperature:**
 - Using the camcorder in a place where the temperature is over 104°F (40°C) or lower than 32°F (0°C) may result in abnormal recording/playback.
 - Do not leave the camcorder on a beach or in a closed vehicle where the temperature is very high for a long time: This could cause a malfunction.
- **Do not point directly at the sun:**
 - If direct sunlight strikes the lens, the camcorder could malfunction or a fire could occur.
 - Do not leave the camcorder with the LCD screen exposed to direct sunlight: This could cause a malfunction.
- **Do not use the camcorder near TV or radio:**
 - This could cause noise to appear on the TV screen or in radio broadcasts.
- **Do not use the camcorder near strong radio waves or magnetism:**
 - If the camcorder is used near strong radio waves or magnetism, such as near a radio transmitter tower or electric appliances, noise could enter video and audio that are being recorded. During playback of normally recorded video and audio, noise may also be present in picture and sound.
- **Do not expose the camcorder to soot or steam:**
 - Thick soot or steam could damage the camcorder case or cause a malfunction.
- **Do not use the camcorder near corrosive gas:**
 - If the camcorder is used in a place where there is dense exhaust gas generated by gasoline or diesel engines, or corrosive gas such as hydrogen sulphide, the external or internal terminals could corrode, disabling normal operation, or the battery connection terminals could corrode, so that power will not turn on.
- **Do not use the camcorder near an ultrasonic humidifier:**
 - Calcium and other chemicals dissolved in water could scatter in the air, and white particles could adhere to the optical head of the camcorder, which could cause it to operate abnormally.
- **Do not clean the camcorder body with benzene or thinner:**
 - The coating of exterior could peel off or the case surface could deteriorate.
 - When using a chemical cleaning cloth, follow the instructions.
- **Keep the memory card out of reach of children to prevent swallowing.**
- **To disconnect the apparatus from the mains, the plug must be pulled out from the mains socket, therefore the mains plug shall be readily operable.**

important information on use

ABOUT THIS USER MANUAL

- This User Manual covers models SMX-C10RN, SMX-C10LN, SMX-C10GN, SMX-C13RN, SMX-C13LN, SMX-C13GN, SMX-C14RN, SMX-C14LN, SMX-C14GN, SMX-C100RN, SMX-C100LN and SMX-C100GN. The SMX-C13RN, SMX-C13LN and SMX-C13GN have a 8GB built in flash memory respectively, but also use memory cards. The SMX-C14RN, SMX-C14LN and SMX-C14GN have a 16GB built in flash memory respectively, but also use memory cards. The SMX-C10RN, SMX-C10LN, SMX-C10GN, SMX-C100RN, SMX-C100LN and SMX-C100GN does not have built-in flash memory and uses memory cards exclusively. Although some features of SMX-C10RN, SMX-C10LN, SMX-C10GN, SMX-C13RN, SMX-C13LN, SMX-C13GN, SMX-C14RN, SMX-C14LN, SMX-C14GN, SMX-C100RN, SMX-C100LN and SMX-C100GN are different, they operate in the same way.
- Illustrations of model SMX-C10N are used in this user manual.
- The displays in this user manual may not be exactly the same as those you see on the LCD screen.
- Designs and specifications of storage media and other accessories are subject to change without any notice.
- In this user manual's function descriptions, the icon on the on-screen display section means that it will appear on the screen when you set the corresponding function.

Ex) Submenu item of **"Video Resolution"** → page 58

item	contents	on-screen display
"TV Super Fine"	Videos recorded in 720x480(60i) resolution at super-fine image quality.	

(If set, corresponding icon () will appear on the screen.)

- Descriptions of the "Photo" and "built-in memory" in this user manual apply only to the following models: SMX-C13, SMX-C14

NOTES REGARDING TRADEMARK

- All the trade names and registered trademarks mentioned in this manual or other documentation provided with your Samsung product are trademarks or registered trademarks of their respective holders.
- Windows® is registered trademark or trademark of Microsoft Corporation, registered in the United States and other countries.
- Macintosh is trademark of Apple Inc.
- YouTube® is a trademark of Google Inc.
- Flickr® is a trademark of Yahoo.
- All the other product names mentioned herein may be the trademark or registered trademarks of their respective companies.
- Furthermore, "TM" and "®" are not mentioned in each case in this manual.

precautions during use

The safety precautions illustrated below are to prevent personal injury or material damage. Heed all instructions carefully.

WARNING
Death or risk of serious personal injury.

 Prohibited action.

 Do not touch product.

 Unplug from power supply.

CAUTION
Means that there is a potential risk of personal injury or material damage.

 Do not disassemble product.  This precaution must be kept.

WARNING

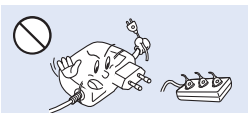

Do not overload outlets or extension cords as this may result in abnormal heat or fire.



Using the camcorder at temperatures over 140°F (60°C) may result in fire. Keeping the battery at a high temperature may cause an explosion.



Do not allow water or metal and inflammable matter to enter the camcorder or AC power adaptor. Doing so may pose a fire hazard.

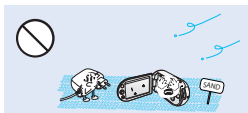

No sand or dust! Fine sand or dust entering the camcorder or AC power adaptor could cause malfunctions or defects.



No oil! Oil entering the camcorder or AC power adaptor could cause electric shock, malfunctions or defects.



Do not aim the LCD screen directly into the sun. Doing so could cause eye injuries, as well as lead to malfunctioning of internal parts of the product.



Do not bend the power-cord or damage the AC power adaptor by pressing on it with a heavy object. There may be a risk of fire or electric shock.



Do not disconnect the AC adaptor by pulling on its power-cord, as this could damage the power-cord.

precautions during use

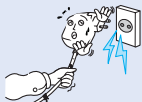

Do not use the AC adaptor if it has damaged, split or broken cords or wires. Doing so may cause fire or electric shock.

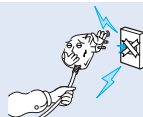

Do not connect the AC adaptor unless the plug can be fully inserted with no part of the blades exposed.



Do not dispose of battery pack in a fire as it may explode.

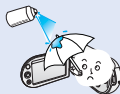

Never use cleaning fluid or similar chemicals. Do not spray cleaners directly on the camcorder.



Keep the camcorder away from water when used near the beach or pool or when it rains. There is a risk of malfunction or electric shock.



Keep the used lithium battery or memory card out of the reach of children. If the lithium battery or memory card is swallowed by children, consult a physician immediately.



Do not attempt to disassemble, repair, or reform the camcorder or the AC adaptor to avoid a risk of fire or electric shock.

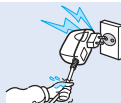

Do not plug or unplug the power cord with wet hands. There is a risk of electric shock.



Keep the power-cord unplugged when not in use or during lightning storms to prevent fire hazard.



When cleaning the AC adaptor, unplug the power-cord to avoid a risk of a malfunction or electric shock.



If the camcorder makes an abnormal sound, or smells or smokes, unplug the power-cord immediately and request service from a Samsung service center. There is a risk of fire or personal injury.

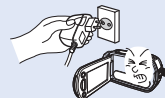

If the camcorder malfunctions, immediately detach the AC adaptor or battery from the camcorder immediately to avoid fire or injury.

 **CAUTION**

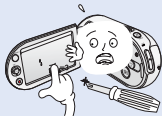

Do not press the surface of the LCD with force, or hit it with a sharp object. If you push the LCD surface, display unevenness may occur.

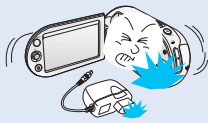

Do not drop or expose the camcorder, battery pack, AC adaptor or other accessories to severe vibrations or impact. This may cause a malfunction or injury.

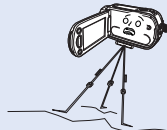

Do not use the camcorder on a tripod (not supplied) in a place where it is subject to severe vibrations or impact.



Do not use the camcorder in direct sunlight or near heating equipment. This will especially shorten the operation range of the remote control which uses infrared rays.

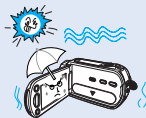

Do not expose the camcorder to sand or water when recording at the beach or pool, or recording on a rainy day. Doing so may cause a malfunction or electric shock.

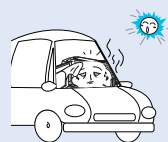

Do not leave the camcorder in a closed vehicle where the temperature is very high for a long time.

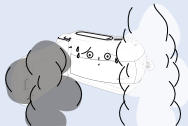

Do not expose the camcorder to soot or steam. Thick soot or steam could damage the camcorder case or cause a malfunction.



Do not use the camcorder near dense exhaust gas generated by gasoline or diesel engines, or corrosive gas such as hydrogen sulphide. Doing so may corrode the external or internal terminals, disabling normal operation.



Do not expose the camcorder to insecticide. Insecticide entering the camcorder could cause the product to operate abnormally. Turn the camcorder off and cover it with vinyl sheet, etc. before using insecticide.

precautions during use

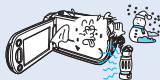

Do not expose the camcorder to sudden changes in temperature or a humid places. There is also a risk of defect or electric shock when using outdoors during lightning storms.



Do not place the camcorder with the open LCD screen down.



Do not wipe the camcorder body with benzene or thinner. The exterior coating could peel off or the case surface could deteriorate.

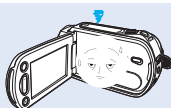

Do not leave the LCD monitor open when not using the camcorder.



Do not hold the camcorder by the LCD monitor when lifting it. The LCD monitor could detach and the camcorder may fall.

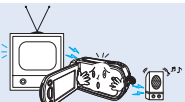

Do not use the camcorder near TV or radio. This could cause noise on the TV screen or to radio broadcasts.



Do not use the camcorder near strong radio waves or magnetism such as speakers or large motors. Noise could enter video or audio that are being recorded.



Use Samsung-approved accessories only. Using products from other manufacturers may cause overheating, fire, explosion, electric shock or personal injuries due to abnormal operation.

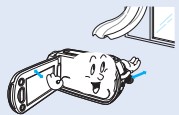

Place the camcorder on a stable surface and a place with ventilation openings.

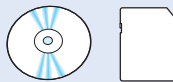

Keep important data separately. Samsung is not responsible for data loss.

contents

QUICK START GUIDE

07

07 You can record videos in H.264 format!

GETTING TO KNOW YOUR CAMCORDER

PREPARATION

14

11 What's included with your camcorder
12 Front & left view
13 Rear & bottom view

14 Using the hand strap
14 Adjusting the LCD screen
15 Basic camcorder positioning
16 Connecting a power source
24 Basic operation of your camcorder
25 LCD screen indicators
31 Turning the screen indicators on/off (I/O)
33 Shortcut menu (OK GUIDE)
35 Initial setting : Time Zone, Date And Time & OSD Language

ABOUT THE STORAGE MEDIA

38

38 Selecting the storage media (SMX-C13/C14 only)
39 Inserting / ejecting the memory card
40 Selecting a suitable memory card
43 Recordable time and capacity

RECORDING

45

45 Recording movie images
46 Recording with ease for beginners (EASY Q Mode)
47 Taking photo images (SMX-C13/C14 only)
48 Zooming in and out

contents

PLAYBACK

49

RECORDING OPTIONS

54

PLAYBACK OPTIONS

71

- 49 Changing the playback mode (SMX-C13/C14 only)
- 50 Playing movie images
- 53 Viewing photo images (SMX-C13/C14 only)

- 54 Changing the menu settings
- 56 Menu items
- 57 Using the recording menu items
- 57 iSCENE
- 58 Video resolution
- 59 Photo resolution
- 59 16:9 Wide
- 60 EV (Exposure Value)
- 61 Back light
- 62 Focus
- 62 Face detection
- 64 Anti-Shake (HDIS)
- 65 Digital effect
- 66 Fader
- 66 Wind cut
- 67 Digital zoom
- 68 Time lapse REC
- 70 Guideline

- 71 Menu items
- 72 Play option
- 73 Delete
- 74 Protect
- 75 Story-board print
- 76 Copy (SMX-C13/C14 only)
- 78 Divide
- 80 Combine
- 81 Share mark
- 82 Slide show (SMX-C13/C14 only)
- 83 File info

SETTINGS OPTIONS

84

- 84 Changing the menu settings in "Settings"
- 85 Menu items
- 86 Using the settings menu items
- 86 Storage (SMX-C13/C14 only)
- 86 Storage Info
- 87 Format
- 87 File No.
- 88 Time Zone
- 90 Date/Time Set
- 90 Date Type
- 90 Time Type
- 91 Date/Time Display
- 91 LCD Brightness
- 91 LCD Color
- 92 LCD Enhancer
- 92 Auto LCD Off
- 92 Menu Design
- 92 Transparency
- 93 Beep Sound
- 93 Shutter Sound (SMX-C13/C14 only)
- 93 Auto Power Off
- 94 PC Software
- 94 TV Display
- 94 Default Set
- 95 Version
- 95 Language
- 95 Demo

USING WITH A WINDOWS COMPUTER

96

- 96 Checking your computer type
- 97 What you can do with a Windows computer
- 98 Using the Intelli-studio program
- 105 Transferring videos/photos from the camcorder to your computer

contents

CONNECTING TO OTHER DEVICES

107

- 107 Connecting to a TV
- 108 Viewing on a TV screen
- 109 Recording (dubbing) images on a VCR or DVD/HDD recorder

MAINTENANCE & ADDITIONAL INFORMATION

110

- 110 Maintenance
- 111 Additional information
- 113 Using your camcorder abroad

TROUBLESHOOTING

- 114 Troubleshooting

SPECIFICATIONS

- 127 Specifications

quick start guide



- ✦ This quick start guide introduces the basic operation and features of your camcorder. See the reference pages for more information.

You can record videos in H.264 format!

You can record videos in H.264 format, which enables you to conveniently email and share videos with your friends and family. You can also take photos with your camcorder (SMX-C13/C14 only).

Step1: Get ready

1. Insert a memory card. ↪ page 39
 - You can use commercially available SDHC (SD High Capacity) or MMC plus cards with this camcorder.
 - Set the appropriate storage media. (SMX-C13/C14 only)
2. Insert the battery into the battery slot. ↪ page 16
 - Gently slide the **Battery pack release** switch in the direction as shown in the figure.

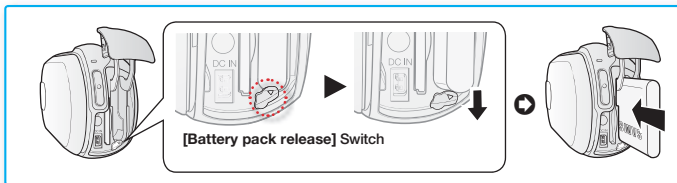
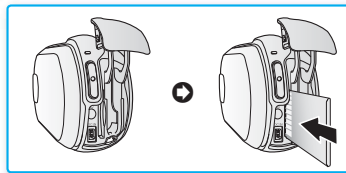

quick start guide

Step 2: Record with your camcorder

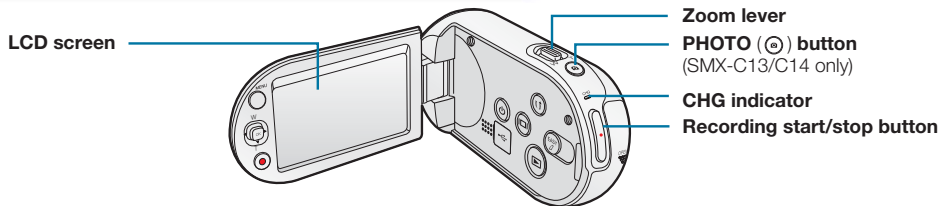

RECORDING VIDEOS WITH H.264 FORMAT

Your camcorder uses advanced H.264 compression technology to realise the clearest video quality.

→ page 106

1. Open the LCD screen.
2. Press the **Power** (⊙) button.
3. Press the **Recording start/stop** button.
 - To stop recording, press the **Recording start/stop** button.

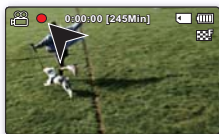

- Your camcorder is compatible with H.264 recording format, which achieves efficient coding of high quality video with less capacity.
- You can record videos in SD(standard definition). The default setting is "TV Fine (720x480/60i)". → page 58
- You can not take photos while you are recording videos.

RECORDING PHOTOS (SMX-C13/C14 ONLY)

1. Open the LCD screen.
2. Press the **Power** (⊙) button.
3. Press the **PHOTO** (⊙) button fully when you are ready.

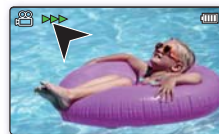

Step 3: Play back videos or photos

VIEWING THE LCD SCREEN OF YOUR CAMCORDER

You can find your desired recordings quickly by using the thumbnail index view.

1. Press the **Mode** (Ⓜ) button to select the Play mode.
 - The thumbnail index view appears. The thumbnail of the latest created or played file is highlighted.
2. Set the Play Mode to **“Video”** or **“Photo”**. (SMX-C13/C14 only)
 - Press the **MENU** button. Use the **Control** button to select **“Play Mode”** → **“Video”** or **“Photo”**.
3. Use the **Control** button to select a desired video or photo, and then press the **Control** button (OK).



- Setting the Play Mode menu is available in thumbnail view only. (SMX-C13/C14 only)
- The photo function is available with model SMX-C13/C14 only.

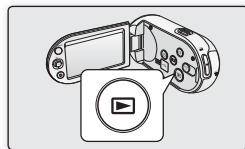

(SMX-C13/C14 only)

VIEWING ON A TV

- You can enjoy detailed, brilliant quality videos on a connected TV. ↪ page 108

Step 4: Save recorded videos or photos

Simple and fun! Enjoy the various features of Intelli-studio on your Windows computer.

Using the Intelli-studio program built in your camcorder, you can import videos/photos into your computer, edit or share the videos/photos with your friends. For details, see page 98.



quick start guide

IMPORTING AND VIEWING VIDEOS/PHOTOS FROM THE CAMCORDER TO YOUR PC

1. Launch the Intelli-studio program by connecting the camcorder to your PC via the USB cable.
 - A new file saving screen appears with the Intelli-studio main window. Click **"Yes"**, the uploading procedure will start.
2. Click **"Import folder"** to import the videos or photos from the PC to the Intelli-studio, you will see the files location on the Intelli-studio browser.
3. You can double-click on the file you would like to start playing.

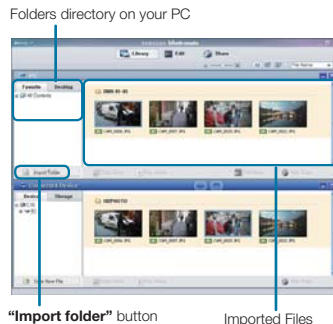

SHARING VIDEOS/PHOTOS ON YouTube/Flickr

Share your contents with the world, by uploading photos and videos directly to a web site with a single click. Click on the **"Share"** → **"Upload to Share Site"** tab on the browser. ↪ page 101

 The Intelli-studio runs automatically once the camcorder is connected to a Windows computer (when you specify **"PC Software: On"**). ↪ page 94

Step 5: Delete videos or photos

If the storage media is full, you cannot record new videos or photos. Delete videos or photos data that have been saved on a computer from the storage media. Then you can record new videos or photos on newly freed-up space.

Press the Mode (C) button to switch the Play mode → Press the MENU button → Control button (▲/▼/◀/▶/OK) to select "Delete." ↪ page 73

 The photo function is available with models SMX-C13/C14 only.

getting to know your camcorder

WHAT'S INCLUDED WITH YOUR CAMCORDER

Your new camcorder comes with the following accessories. If any of these items are missing from your box, call Samsung's Customer Care Center.

★ The exact shape of each item may vary by model.



Battery pack
(IA-BH130LB)
AD43-00190A



AC power adaptor
(AA-MA9 type)
AD44-00151A



Audio/Video Cable
AD39-00168A

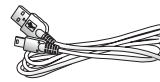

USB Cable
AD39-00169A

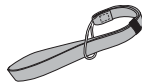

Hand strap
AD63-04220A



Quick start guide
AD68-03824A



User manual CD
AD46-00256A



Carrying case
(SMX-C10RN/CLB only)
(SMX-C14RN/QVC only)
AD69-00890A



Memory card
(Optional)
1109-001415



Carrying case
(Optional)
AD69-00929A



- The contents may vary depending on the sales region.
- Parts and accessories are available for purchase at your local Samsung dealer. SAMSUNG is not responsible for reduced battery life time or malfunctions caused by any unauthorized use of accessories such as the AC adaptor or the batteries.
- A memory card is not included. See page 40 for memory cards compatible with your camcorder.
- Your camcorder includes a user manual CD and a quick start guide (printed).
- (Optional) : This is an optional accessory. To buy one, contact your nearest Samsung dealer.

getting to know your camcorder

FRONT & LEFT VIEW

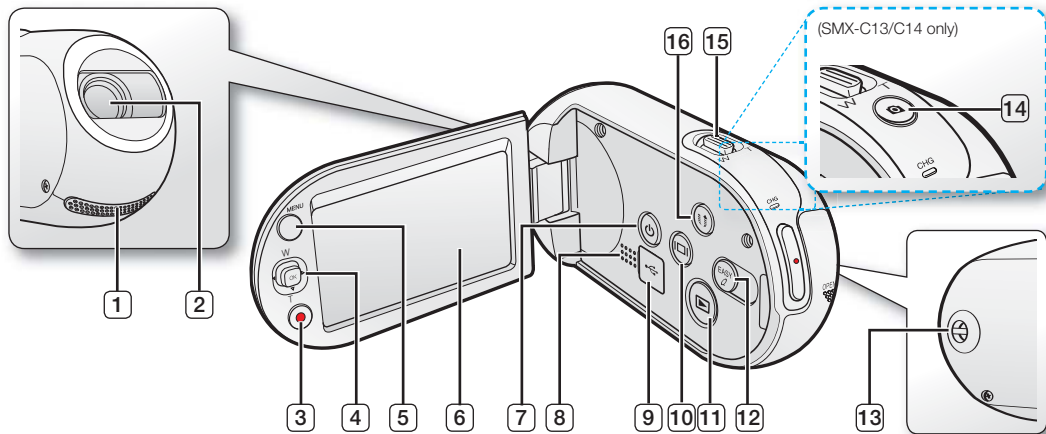

1 Internal microphone

2 Lens

3 Recording start/stop button

4 Control button (▲/▼/◀/▶/OK), Zoom(W/T) button

5 MENU button

6 LCD screen

7 Power (Ⓢ) button

8 Built-in speaker

9 USB jack (⚡)

10 Display (⏏) button

11 Mode (Ⓢ) button

12 EASY Q button

13 Hand strap hook

14 PHOTO (📷) button (SMX-C13/C14 only)

15 Zoom lever (W/T)

16 Share (📷) button



Be careful not to cover the internal microphone and lens during recording.

REAR & BOTTOM VIEW

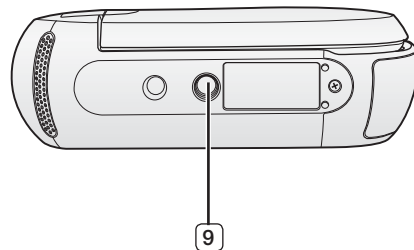
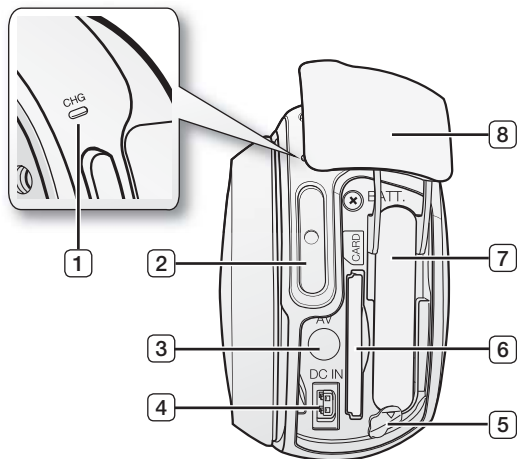

- 1 Charging indicator (CHG)
- 2 Recording start/stop button
- 3 AV cable jack (AV)
- 4 DC IN jack (DC IN)
- 5 Battery pack release switch

- 6 Memory card slot
- 7 Battery pack slot
- 8 Jack/ Battery pack/ Memory card cover
- 9 Tripod receptacle

Usable Memory Cards (32GB Max)

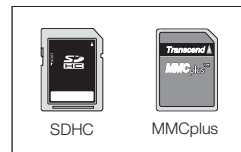

preparation

This section provides information that you should know before using this camcorder; such as how to use the provided accessories, how to charge the battery, and how to setup the operation mode and initialise setup.

USING THE HAND STRAP

Attach the strap and place your hand through the loop to prevent the camcorder from damage by being dropped.

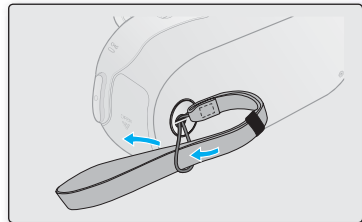

ADJUSTING THE LCD SCREEN

The wide LCD screen on your camcorder offers high quality image viewing.

1. Open the LCD screen with your finger.
 - The screen opens up to 90°.
2. Rotate the LCD screen towards the lens.
 - You can rotate it up to 180° towards the lens and up to 90° backward. To view recordings more conveniently, rotate the screen by 180° towards the lens, then fold it back to the body.

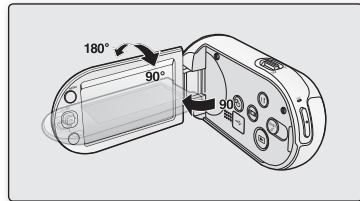

Excessive rotation may damage the connective hinge between the screen and the camcorder.



- Remove fingerprints or dust on the screen with a soft cloth.
- When the LCD screen is rotated by 180° toward the lens, the left and the right sides of the subject are shown in reverse as if you were looking at a mirror. This is not a problem and does not affect the image being recorded.

BASIC CAMCORDER POSITIONING

Use both hands while taking a video or picture to prevent the camcorder from shaking. Try to avoid any slight movement while shooting.

Adjusting the shooting angle

Aim the camcorder as shown in the illustration.

1. Hold the camcorder with both hands.
2. Hook up the hand strap to fit to hand.
3. Make sure your footing is stable and there is no danger of colliding with another person or object.
4. Aim and focus as shown in the illustration.

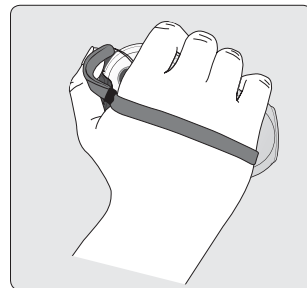

- This camcorder lens shooting angle is approx. 25° higher than the rest of the camcorder body. Make sure the camcorder lens is angled for proper shooting.
- It is recommended to keep the sun behind you while shooting.

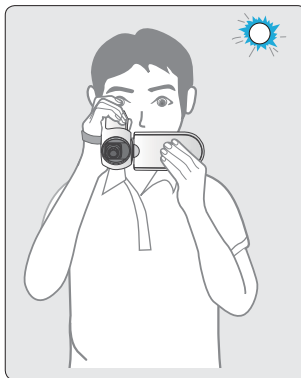

preparation

CONNECTING A POWER SOURCE

- Be sure to charge the battery pack before you start using your camcorder.
- Use the **IA-BH130LB** battery pack only.
- The battery pack may be charged a little at the time of purchase.

Battery pack insertion/ejection

It is recommended you purchase one or more additional battery packs to allow continuous use of your camcorder.

Inserting the battery pack

1. Slide and open the battery slot cover as shown in the figure.
2. Insert the battery pack into the battery slot until it locks.
 - Make sure that the SAMSUNG logo is facing left while the battery pack is placed as shown in the figure.
3. Slide and close the battery slot cover.

Ejecting the battery pack

1. Slide and open the battery slot cover and push the **Battery pack release** switch.
 - Gently push the **Battery pack release** switch in the direction as shown in the figure to eject the battery.
2. Pull the ejected battery out in the direction as shown in the figure.
3. Slide and close the battery slot cover.



- Remove the battery pack separately from the camcorder while not in use.
- It is recommended to prepare an additional battery pack for prolonged outdoor use.
- Additional battery packs can be purchased from samsungparts.com.

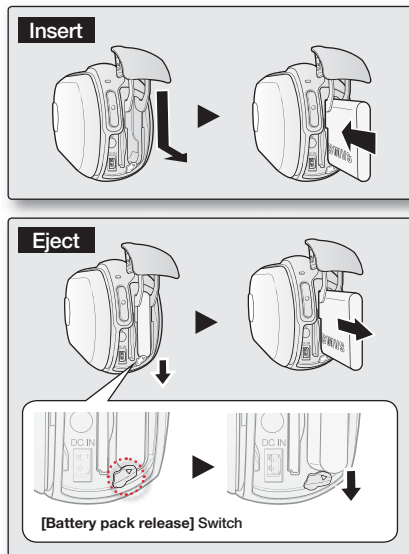

Charging the battery

You can charge the battery using the AC power adaptor or USB cable.

1. Insert the battery in the camcorder. ➔page 16
2. Press the **Power** (⏻) button to turn off the camcorder.
3. Open the connector cover of the unit.
4. Charge the battery using the **AC power adaptor or USB cable**.
 - The CHG (charge) lamp lights up and charging starts. When the battery is fully charged, the charging (CHG) lamp turns green.
➔page 18

Using the AC power adaptor	Connect the AC power adaptor to the camcorder properly and plug the AC Power adaptor in the wall outlet.
Using the USB cable	Connect the USB cable to the camcorder properly and connect the other end to a USB port of a PC.

Connecting the AC power adaptor

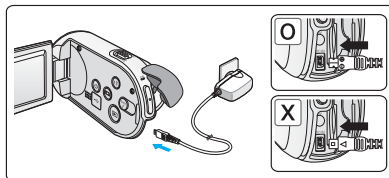

Connecting the USB cable

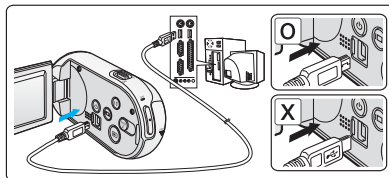

CAUTION

- Charging the battery pack at low temperature may take longer or fail to fully charge (green indicator will not turn on).
- Please make sure that there are no foreign substances in the plug and socket when you connect the AC power supply to the camcorder.
- Fully charge the battery pack before use.
- When using the AC power supply, place it close to the wall outlet. If you experience a malfunction while using the camcorder, separate the AC power supply immediately from the wall outlet.
- Do not use the AC power supply in a tight space, such as between furnishings.
- When recording indoors with an available wall outlet, it is convenient to use the AC power supply instead of the battery pack.
- It is recommended to charge the battery pack in a place with ambient temperature of 50°F~86°F (10°C ~ 30°C).
- When charging, if both the USB cable and AC power adaptor are connected, the AC power adaptor will override the USB.
- If the camcorder is turned on, the battery will still charge, but more charging time will be needed. It is recommended you to keep the camcorder turned off while charging.



preparation

Charging indicator

Tips for battery identification

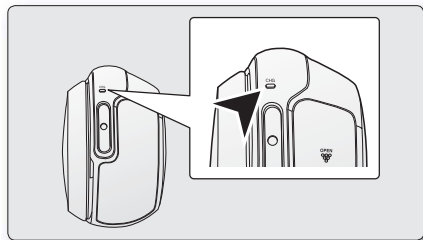

- ★ The color of the LED indicates the charging status.
 - If the battery has been fully charged, the charge indicator is green.
 - While the battery is being charged, the charge indicator lights orange.
 - If an error occurs while the battery is being charged, the charge indicator blinks orange.



<Charging indicator>

Charging (CHG) lamp







The color of the charging indicator shows the charging state.

Charging state	Charge	
	Charging	Fully Charged
LED Color	 (Orange)	 (Green)

- If there is no operation for more than 5 minutes when the LCD screen is closed, the charging lamp blink green to indicate the camcorder is powered on. (uses the battery as main power and make sure the **"Auto Power Off"** set on **"off"**)

Battery Level Display

The Battery Level Display shows the amount of battery power remaining in the battery pack.

Battery Level Indicator	State	Message
	Fully charged	-
	20%~40% used	-
	40%~60% used	-
	60%~80% used	-
	80%~99% used	-
	Exhausted (flickers): The device will soon turn off. Change the Battery Pack as soon as possible.	-
-	(flickers): The device will be forced to turn off after 3 seconds.	"Low battery"

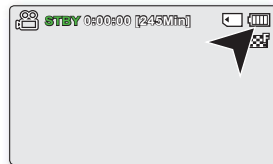





- Before using the camcorder, charge the battery.
- Above figures are based on a fully charged battery pack at normal temperature. Low ambient temperature may affect the use time.

preparation

Charging, recording and playback times with fully charged battery pack (with no zoom operation, etc.)

- For your reference, the approximate time with fully charged battery pack:

Battery type		IA-BH130LB				
Charging time		Using a AC power adaptor			approx. 2 hr.	
		Using a USB cable			approx. 4 hr.	
Movie resolution		720 x 480 (60i)			640 x 480 (30p)	
		TV Super Fine ()	TV Fine ()	TV Normal ()	Web Fine ()	Web Normal ()
Mode	Continuous recording time	approx. 160min.				
	Playback time	approx. 180min.				

- The time is only for reference. Figures shown above are measured under Samsung's test environment, and may differ according to user and condition.
- We recommend using the AC power adaptor when using the Time Lapse REC Function.

Continuous Recording (without zoom)

The continuous recording time of the camcorder in the table shows the available recording time when the camcorder is in the recording mode without using any other function after recording starts. When actually recording, the battery pack may discharge 2-3 times faster than this reference, since the record start/stop and zoom functions are being operated, and playback is performed. Prepare additional charged battery pack(s) to allow for the time you are planning to record on the camcorder. Note that the battery pack discharges faster in a cold environment.



The charging time will vary depending on the remaining battery level.

About the battery pack

- The benefits of the battery pack: the Battery pack is small but has a large power capacity. It should be recharged at temperatures between 50°F ~ 86°F (10°C ~ 30°C).
However, when it is exposed to cold temperatures (below 32°F (0°C)), its usage time is reduced and it may cease to function. If this happens, place the battery pack in your pocket or any other warm, protected place for a short time, then reattach it to the camcorder.
- The continuous recording times in the operating instructions are measured using a fully charged battery pack at 25 °C (77 °F). As the environmental temperature and conditions vary, the remaining battery time may differ from the approximate continuous recording times given in the instructions.

Handling the battery pack

- To preserve battery power, keep your camcorder turned off when you are not operating it.
- To save battery power, you can set the **"Auto Power Off"** function, which turns off the camcorder if there is no operation for 5 minutes. To disable this option, change the setting of **"Auto Power Off"** to **"Off"** →page 93
- Do not allow metallic objects to come into contact with the terminals.
- Make sure that the battery pack fits firmly into place. Do not drop the battery pack.
Dropping the battery pack may cause damage.
- Be careful to keep the battery pack out of the reach of children. It is a choking hazard if swallowed.
- Frequent use of the LCD screen or using the fast forward or rewind buttons wears out the battery pack faster.
- Remove the battery pack from the camcorder for safekeeping after using your camcorder.
- Leaving the battery pack for an extended period of time may discharge the battery pack completely.
 - A battery pack which is completely discharged may not turn on the recharging LED during charging.
It is designed to protect the battery pack. If the recharging LED turns on normally within 5 minutes, use the battery pack as normal.

preparation

Maintaining the battery pack

- We recommend only using the original battery pack that is available from your Samsung retailer. When the battery reaches the end of its life, please contact your local dealer. The batteries have to be dealt with as chemical waste.
- Clean the terminals to remove any foreign substances before inserting the battery.
- Do not put the battery pack near any heat source (i.e. fire or heater).
- Do not disassemble, apply pressure to, or heat the battery pack.
- Do not allow the '+' and '-' terminals of the battery pack to be short-circuited.
It may cause leakage, heat generation, induce overheating or fire.
- Do not expose the battery pack to water. The battery pack is not water resistant.
- When fully discharged, a battery pack damages the internal cells.
The battery pack may be prone to leakage when fully discharged.
- Remove the battery pack from the charger or camcorder when not in use. Even when the power is switched off, the battery pack will still discharge if it is left attached to the camcorder.
- When not using the camcorder for an extended period:
It is recommended that you fully charge the battery pack once every 6 months, attach it to the camcorder and use it up: then remove the battery pack and store it in a cool place.

About the battery life

- Battery capacity decreases over time and through repeated use. If decreased usage time between charges becomes significant, it is probably time to replace it with a new one.
- Each battery's life is governed by storage, operating and environmental conditions.

Use only Samsung-approved battery packs.

Do not use batteries from other manufacturers because there is a danger of overheating, fire or explosion.

Samsung is not responsible for problems occurring due to using unapproved batteries.

Using a household power source

Make the same connections as you do when charging the battery pack.
The battery pack will not lose its charge in this case.

Using the camcorder with the AC power adaptor

It is recommended that you use the AC power adaptor to power the camcorder from a household AC outlet when you perform settings on it, play back, or use it indoors.

- Make the same connections as you do when charging the battery pack. ➔page 17



CAUTION

- Before detaching the power source, make sure that the camcorder's power is turned off. Failure to do so can result in camcorder malfunction.
 - Use a nearby wall outlet when using the AC power adaptor. Disconnect the AC power adaptor from the wall outlet immediately if any malfunction occurs while using your camcorder.
 - Do not use the AC power adaptor in a narrow space, such as between a wall and furniture.
-
- 
- Be sure to use the specified AC power adaptor to power the camcorder. Using other AC power adaptors could cause electric shock or result in fire.
 - The AC power adaptor can be used around the world. An AC plug adaptor is required in some foreign countries. If you need one, purchase it from your distributor.

Auto Power Off Function

To save battery power, you can set the **"Auto Power Off"** function which turns off the camcorder if there is no operation for 5 minutes. To disable this option, change the setting of **"Auto Power Off"** to **"Off."** ➔page 93

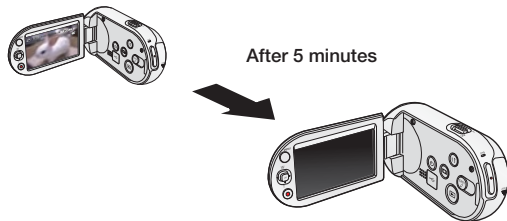

preparation

BASIC OPERATION OF YOUR CAMCORDER

This section explains the basic techniques of recording movie or photo images and also basic settings on your camcorder. Set the appropriate operation mode according to your preference using **Power** (⏻) button and **Mode** (⏻) button.

Turning the camcorder on or off

You can turn the power on or off by pressing the **Power** (⏻) button.

1. Open the LCD screen and press the **Power** (⏻) button to turn on the camcorder.
2. To turn off the camcorder, press the **Power** (⏻) button.

Setting the operating modes

- You can switch the operating mode in the following order each time you press the **Mode** (⏻) button.
 - Record mode → Play mode → Record mode

Mode	Functions
Record mode	To record movie or photos (SMX-C13/C14 only).
Play mode	To play movie or photos (SMX-C13/C14 only), or edit them.

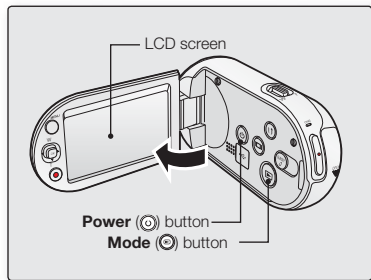

When using this camcorder for the first time

- When you use your camcorder for the first time or reset it, the time zone screen appears for the startup display. Select your geographical location and set the date and time. If you do not set the date and time, the time zone screen appears every time you turn on the camcorder.

- This camcorder provides one record mode for both movie and photo recordings. You can easily record movies or photos in the same mode without having to switch modes. (SMX-C13/C14 only)
- When the camcorder is turned on, the self-diagnosis function operates and a message may appear. In this case, refer to "Warning indicators and messages" (on pages 114-116) and take corrective action.

LCD SCREEN INDICATORS

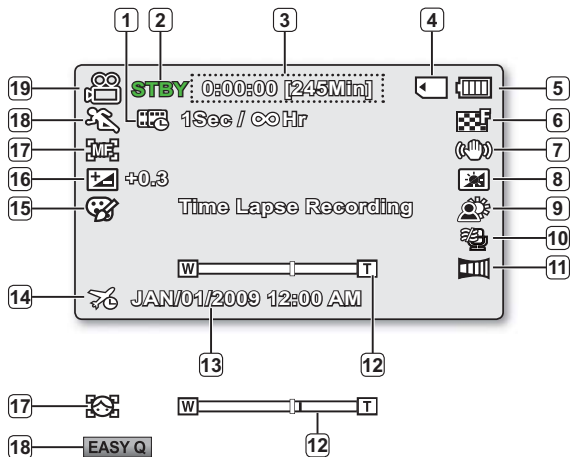

Movie Record mode (SMX-C10/C100 only)

- | | |
|----|---|
| 1 | Time Lapse REC * |
| 2 | Operating mode (STBY (Standby) / ● (Recording)) |
| 3 | Time counter
(movie recording time: remaining recordable time) |
| 4 | Storage media (memory card) |
| 5 | Battery info. (Remaining battery level) |
| 6 | Movie image resolution |
| 7 | Anti-Shake (HDIS) |
| 8 | LCD Enhancer * |
| 9 | Back Light |
| 10 | Wind Cut |
| 11 | Fader * |
| 12 | Zoom (Optical zoom / Digital zoom) |
| 13 | Date/Time Display |
| 14 | Time Zone |
| 15 | Digital Effect |
| 16 | EV (Exposure value)* |
| 17 | Manual Focus * / Face Detection * |
| 18 | iSCENE / EASY Q * |
| 19 | Record mode |



- The above screen is an example for explanation: It is different from the actual display.
- The on-screen indicators are based on an 8GB SDHC memory card capacity.
- Functions marked with * will not be kept when the camcorder is turned off and on again.
- For enhanced performance, the display indications and the order are subject to change without prior notice.

preparation

LCD SCREEN INDICATORS

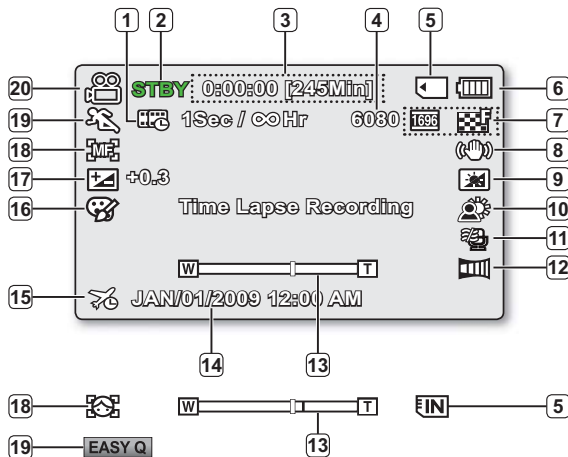

Movie and Photo record mode (SMX-C13/C14 only)

- 1 Time Lapse REC *
- 2 Operating mode (STBY (Standby) / ● (Recording))
- 3 Time counter
(movie recording time: remaining recordable time)
- 4 Photo image counter
(total number of recordable photo images)
- 5 Storage media (Memory card or built-in memory)
(SMX-C13/C14 only)
- 6 Battery info. (Remaining battery level)
- 7 Photo image resolution,
Movie image resolution
- 8 Anti-Shake (HDIS)
- 9 LCD Enhancer *
- 10 Back Light
- 11 Wind Cut
- 12 Fader *
- 13 Zoom (Optical zoom / Digital zoom)
- 14 Date/Time Display
- 15 Time Zone
- 16 Digital Effect
- 17 EV (Exposure value)*
- 18 Manual Focus * / Face Detection *
- 19 iSCENE / EASY Q *
- 20 Record mode



- The above screen is an example for explanation: It is different from the actual display.
- The on-screen indicators are based on an 8GB SDHC memory card capacity.
- Functions marked with * will not be kept when the camcorder is turned off and on again.
- For enhanced performance, the display indications and the order are subject to change without prior notice.
- The photo function is available only with SMX-C13/C14 models.
- This camcorder provides one combined movie and photo record mode. You can easily record movies or photos in the same mode without having to change it. (SMX-C13/C14 only)
- The total number of recordable photos is counted based on available space on the storage media.

LCD SCREEN INDICATORS

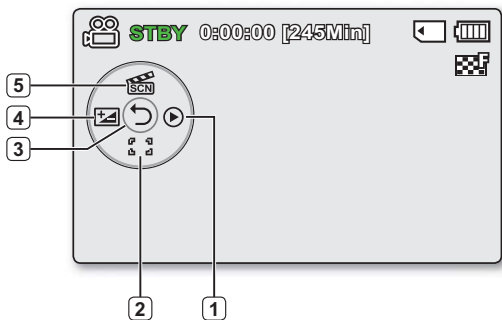

Movie and Photo record mode: Shortcut menu (OK Guide)

- | | |
|---|---|
| 1 | Quick View |
| 2 | Focus* (Auto Focus/Face Detection/Manual Focus) |
| 3 | Shortcut menu (OK Guide) / Return |
| 4 | EV (Exposure value)* |
| 5 | iSCENE |

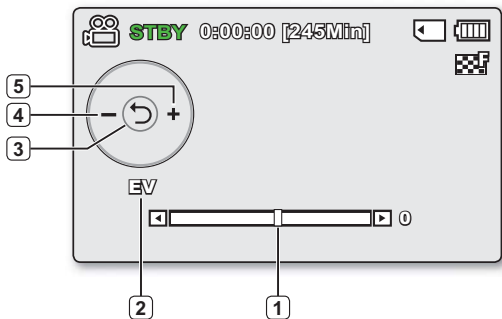

Movie and Photo record mode: Shortcut menu (Manual)

- | | |
|---|-----------------------------------|
| 1 | Manual Control Bar/ Value |
| 2 | Menu name |
| 3 | Shortcut menu (OK Guide) / Return |
| 4 | Value adjust (down) |
| 5 | Value adjust (up) |



- The illustration to the left shows the EV (Exposure value) screen.
- Functions marked with * will not be kept when the camcorder restarts.
- The shortcut menu (OK guide) represents the most frequently accessed functions according to the selected mode. Pressing the OK button will display a shortcut menu of frequently used functions on the LCD screen.

preparation

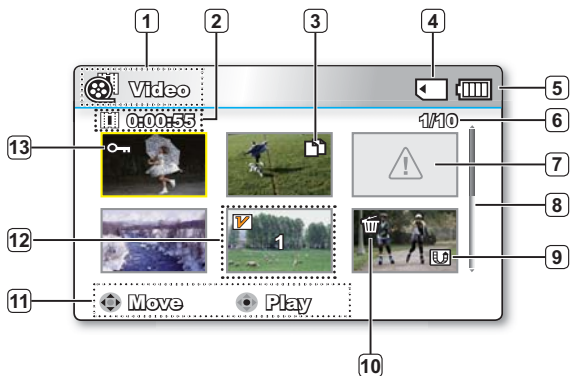

Movie Play mode : Thumbnail View

- | | |
|----|---|
| 1 | Movie Play mode |
| 2 | Recorded time |
| 3 | Copy Selected (SMX-C13/C14 only) |
| 4 | Storage media (Memory card or built-in memory (SMX-C13/C14 only)) |
| 5 | Battery info (Remaining battery level) |
| 6 | Now/ Total file number |
| 7 | Error File |
| 8 | Scroll bar |
| 9 | Share mark |
| 10 | Delete Selected |
| 11 | Button Guide |
| 12 | Edit (Combine) |
| 13 | Protection |

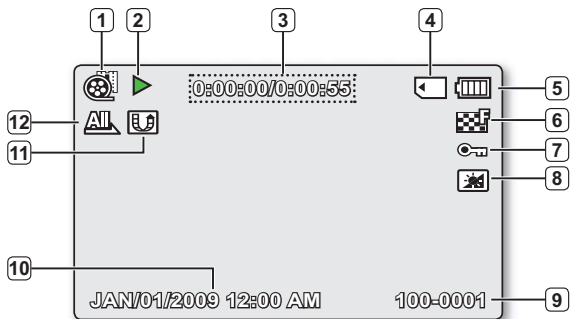

Movie Play mode : Single View

- | | |
|----|---|
| 1 | Movie Play mode |
| 2 | Play Status (Play (▶) / Pause (⏸)) |
| 3 | Time code (Elapsed time / Recorded time) |
| 4 | Storage media (Memory card or built-in memory (SMX-C13/C14 only)) |
| 5 | Battery info (Remaining battery level) |
| 6 | Movie image resolution |
| 7 | Protection |
| 8 | LCD Enhancer |
| 9 | File Name |
| 10 | Date/Time Display |
| 11 | Share mark |
| 12 | Play Option |

LCD SCREEN INDICATORS

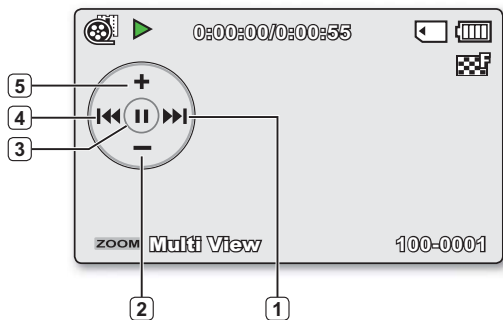

Movie Play mode : Shortcut menu (OK Guide)

- 1 Move to next file / FF (fast forward) ➡ page 32
- 2 Volume Down
- 3 Play (▶) / Pause (II)
- 4 Move to previous file / REW (rewind) ➡ page 32
- 5 Volume Up

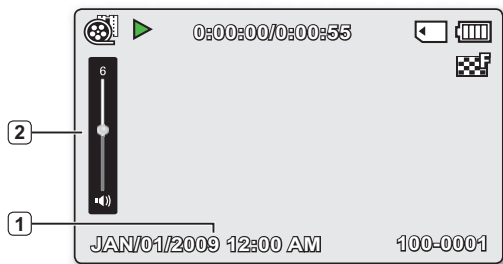

Movie Play mode : Single (Volume)

- 1 Date/Time
- 2 Volume Bar

preparation



Photo Play mode : Thumbnail View (SMX-C13/C14 only)

- 1 Photo Play mode
- 2 Protection
- 3 Storage media (Memory card or built-in memory (SMX-C13/C14 only))
- 4 Battery info (Remaining battery level)
- 5 Now/ Total file number
- 6 Error File
- 7 Scroll bar
- 8 Delete Selected
- 9 Button Guide
- 10 Copy Selected

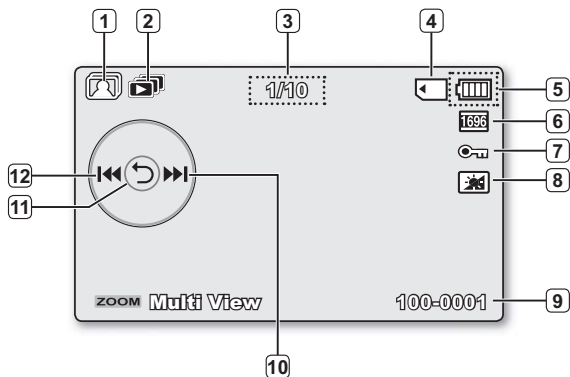

Photo Play mode : Single View (SMX-C13/C14 only)





- 1 Photo Play mode
- 2 Slide Show
- 3 Image counter (current image / total number of recorded images)
- 4 Storage media (Memory card or built-in memory (SMX-C13/C14 only))
- 5 Battery info (Remaining battery level)
- 6 Photo image resolution
- 7 Protection
- 8 LCD Enhancer
- 9 File name (file number)
- 10 OK Guide (Next image)
- 11 Shortcut menu (OK Guide) / Return
- 12 OK Guide (Previous image)



The photo function is available only with SMX-C13/ C14 models.

TURNING THE SCREEN INDICATORS ON/OFF ()

Switching the information display mode

- You can switch the on-screen information display mode:
Press the **Display** () button while the camcorder is on.
The full and minimum display modes will alternate.
 - **Full display mode:** All relevant information will appear.
Minimum display mode: Only operating status indicators will appear.
-  • If the camcorder has warning information, a warning message will appear.
-  • In the menu screen, the **Display** () button will be deactivated.

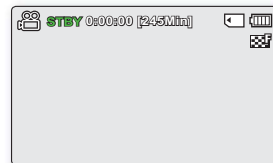
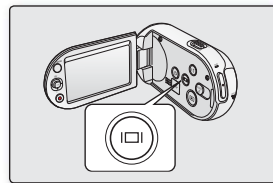



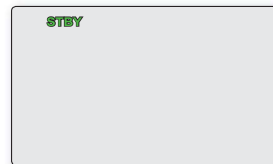



<Full display mode>



<Minimum display mode>

preparation

Using the Control button

Button	Record (📷) mode	Play mode		Menu selection
		Movie Play (🎬) mode	Photo Play (📷) mode	
 OK	<ul style="list-style-type: none"> - Access the shortcut menu - Confirm selection - Exit the shortcut menu 	<ul style="list-style-type: none"> - Shortcut menu (OK guide) is displayed - Playback / Pause 	Single image playback 	Confirms selection
 UP	Zoom (wide)	Increases the volume	-	Moves the cursor up
 DOWN	Zoom (tele)	Decreases the volume	-	Moves the cursor down
 LEFT	-	<ul style="list-style-type: none"> - Search playback RPS (Reverse Playback Search) rate: x2→x4→x8→x16 - Previous Skip Playback 	Previous image	Moves to the previous menu
 RIGHT	-	<ul style="list-style-type: none"> - Search playback FPS (Forward Playback Search) rate: x2→x4→x8→x16 - Next Skip Playback - Frame-by-frame playback - Slow motion playback (Slow Motion Playback Rate: x1/2→x1/4→x1/8→x1/16) 	Next image	Moves to the next menu



The photo function is available only with SMX-C13/C14 models.

SHORTCUT MENU (OK GUIDE)

The Shortcut menu (OK guide) represents the most frequently accessed functions according to the selected mode.

☛ For example: Setting iSCENE in the Record mode using the Shortcut menu (OK guide).

1. Press the **OK** button in STBY mode.
 - The Shortcut menu (OK guide) is displayed.
2. Press the **Control** button (▲) to select “iSCENE” mode.
 - It displays the iSCENE mode menu, where you can press the **Control** button (◀ / ▶) to select the desired submenu item.
3. Press the **OK** button to confirm your selection.
 - The selected submenu item indicator (📷) will display on the screen.
 - Press the **OK** button to exit the shortcut menu.





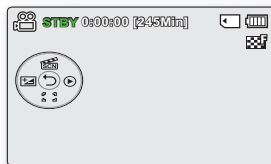
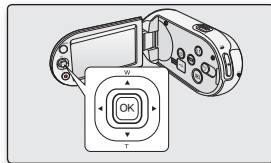





- The Shortcut menu (OK guide) cannot be used in the EASY Q mode.
- Before selecting a menu item, please check that you set the appropriate mode first.



preparation

Shortcut function using the Control buttons

Button	Record (📹) mode	Play mode	
		Video Play (🎞️) mode	Photo Play (📷) mode
 OK	 <ul style="list-style-type: none"> - Access the shortcut menu - Confirm selection - Exit the shortcut menu 	<ul style="list-style-type: none"> - Shortcut menu (OK guide) is displayed - Playback / Pause 	Single image playback 
 UP	iSCENE	Increases the volume	-
 DOWN	Focus	Decreases the volume	-
 LEFT	EV	<ul style="list-style-type: none"> - Search playback RPS (Reverse Playback Search) rate: x2→x4→x8→x16 - Previous Skip Playback 	Previous image
 RIGHT	Quick View	<ul style="list-style-type: none"> - Search playback FPS (Forward Playback Search) rate: x2→x4→x8→x16 - Next Skip Playback - Frame-by-frame playback - Slow motion playback (Slow Motion Playback Rate: x1/2→x1/4→x1/8→x1/16) 	Next image



The photo function is available only with SMX-C13/C14 models.

INITIAL SETTING : TIME ZONE, DATE AND TIME & OSD LANGUAGE

- Initial setting is available in all operating modes.
- To read the menus or messages in your desired language, set the OSD language.
- To store the date and time during recording, set the time zone and date/time.

Turning the power on and setting the date and time

Set the date and time when using the camcorder for the first time.

If you do not set date and time, the date and time (time zone) screen appears every time you turn on your camcorder.

1. Open the LCD Screen and press the **Power** (⏻) button to turn on the camcorder.
 - When you turn on your camcorder for the first time, the Time Zone screen appears based on London, Lisbon. (Greenwich Mean Time)
 - You can also set the Time Zone ("**Home**") in the "**Settings**" menu. ➔page 88
2. Select your geographical area with **Control** button (◀ / ▶), then press the **OK** button.
 - The Date/Time Set screen appears.
3. Select the date and time information, and change the setting values by using the **Control** button (▲ / ▼ / ◀ / ▶).
4. Make sure the clock is correctly set, and then press the **OK** button.



- The year can be set up to 2037, using the "**Home**" menu.
- Activating the (⌚) icon forwards the time by 1 hour.

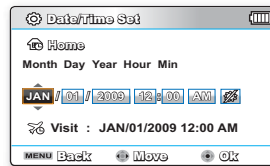
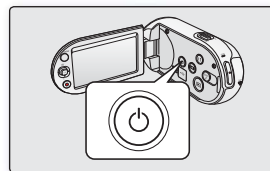

preparation



- **Charging the built-in rechargeable battery**

The built-in battery is always recharged while your camcorder is connected to the AC power or while the battery pack is attached.

If the camcorder is not in use for about **2** months without connecting to the AC power or attaching the battery pack, the built-in battery fully discharges. If this occurs, charge the built-in battery by connecting to the supplied AC adaptor for 24 hours.

- After setting, the date and time are automatically recorded on a special data area of the storage media.

Turning the date and time display on/off

- To switch the date and time display on or off, access the menu and change the Date/Time mode. ➡page 91

Simple setting of the clock by time difference

- You can easily set the clock to the local time by setting a time difference when using your camcorder abroad. Select "**Time Zone**" on the menu, then set the time difference. ➡page 88

INITIAL SETTING : TIME ZONE, DATE AND TIME & OSD LANGUAGE

Selecting the OSD language

You can select the desired language to display the menu screen and the messages.

1. Press the **MENU** button.
 - The menu screen appears.
2. Press the **Control** button (◀ / ▶) to select "**Settings.**"
 - The menus in "**Settings**" mode will appear.
3. Press the **Control** button (▲ / ▼) to select "**Language**", and then press the **OK** button.
4. Press the **Control** button (▲ / ▼) to select the desired OSD language, and then press the **OK** button.
 - English / 한국어 / Français / Deutsch / Italiano / Español / Português / Nederlands / Svenska / Suomi / Norsk / Dansk / Polski / Čeština / Slovensky / Magyar / limba română / Български / Ελληνικά / српски / Hrvatski / Українська / Русский / 中文 / ไทย / Türkçe / العربية / فارسي / IsiZulu
5. Press the **MENU** button to exit the menu.
 - The OSD language is refreshed in the selected language.



- Even if battery pack or AC power are removed, the language setting will be preserved.
- The "**Language**" options may be changed without prior notice.
- The date and time format may change depending on the selected language.

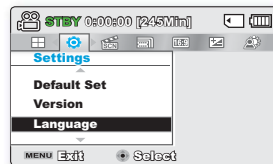

about the storage media

SELECTING THE STORAGE MEDIA (SMX-C13/C14 ONLY)

- You can record on the built-in memory or a memory card, so you should select the desired storage media before starting recording or playback.
- You can use SDHC and MMCplus cards on your camcorder.
(Some cards are not compatible depending on the memory card manufacturer and memory card type.)
- Before inserting or ejecting the memory card, turn the camcorder off.

Selecting the storage media

1. Press the **MENU** button.
 - The menu list will appear.
2. Press the **Control** button (◀ / ▶) to select "**Settings**."
3. Press the **Control** button (▲ / ▼) to select "**Storage**", then press the **OK** button.
4. Press the **Control** button (▲ / ▼) to select "**Memory**" or "**Card**", then press the **OK** button.
 - "**Memory**": When using the built-in memory.
 - "**Card**": When using the memory card.
5. Press the **MENU** button to exit.

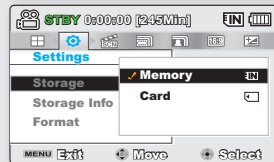
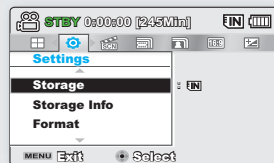

Using the built-in memory (SMX-C13/C14 only)

- Because this camcorder has an embedded 8GB (SMX-C13 only), 16GB (SMX-C14 only) memory, it is not necessary to buy extra storage media.

Using a memory card (not supplied)

- This camcorder has a multi-card slot for access to SDHC (Secure Digital High Capacity) and MMCplus.
- You can use SDHC and MMC plus cards on your camcorder.
 - Some cards are not compatible depending on the memory card manufacturer and memory card type.

- Never format the built-in memory or memory card using a PC.
- If you insert a memory card when the camcorder is on, the pop-up message will prompt you automatically to select the storage type. (SMX-C13/C14 only)
- If there is no memory card inserted, only the built-in memory will be available. (SMX-C13/C14 only)
- Do not eject a memory card while it is being used in the camcorder. The memory card and its data may be damaged.
- Do not remove the power (battery pack or AC power adaptor) when accessing storage media with recording, playback, format, delete, etc. The storage media and its data may be damaged.

INSERTING / EJECTING THE MEMORY CARD

Inserting a memory card

1. Turn the camcorder off.
2. Slide and open the battery/memory card cover as shown in the figure.
3. Insert the memory card into the memory card slot until it softly clicks in the direction of the arrow shown in the figure.
4. Close the cover.

Ejecting a memory card

1. Turn the camcorder off.
2. Slide and open the battery/memory card cover as shown in the figure.
3. Slightly push the memory card inwards to pop it out.
4. Pull the memory card out of the memory card slot and close the cover.

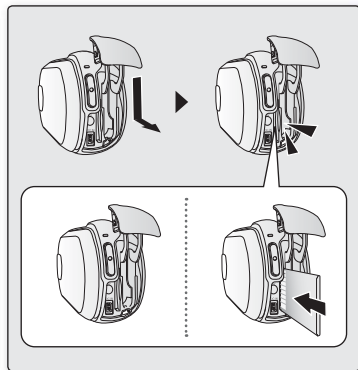

As shown in the figure, be sure to slide the memory card inwards with the label facing right.

about the storage media

SELECTING A SUITABLE MEMORY CARD

A memory card is a compact portable storage media.

- **You can use a SDHC memory card or MMC plus.**
(Memory cards must be purchased separately.)
 - You can also use an SD memory card, but recommended that you use a SDHC memory card or MMC plus with your camcorder.
(SD cards up to 2GB are supported with this camcorder. Normal operation is not guaranteed with SD cards bigger than 2GB.)
- **In this camcorder, you can use memory cards (SDHC or MMCplus) of the following capacity: 512MB ~ 32GB**
- **Compatible recording media**
 - The following recording media have been recommended for use with this camcorder. Others are not recommended, so buy such products with caution.
SDHC or SD memory cards: By Panasonic, SanDisk, and TOSHIBA
MMC plus: By Transcend
- If other media are used, they may fail to record data correctly, or they may lose data that has already been recorded.
- For movie recording, use a memory card that supports faster write speed (at least 2MB/sec).

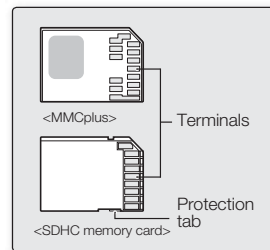

**<Usable Memory Cards>
(512MB ~32GB)**

SDHC (Secure Digital High Capacity) Memory Card

- The SDHC card is a higher version (Ver.2.00) SD card and supports capacity above 2GB.
- An SDHC card has a mechanical write protection switch. Setting the switch prevents accidental erasure of files recorded on the card. To enable writing, move the switch up towards terminals. To set write protection, move the switch down.
- Due to changes In File Allocation System and physical specifications, SDHC memory cards can not be used with current SD enabled host devices. SDHC memory cards can only be used with only SDHC enabled host devices.

MMCplus (Multi Media Card plus)

- With MMCplus, cards have no protection tab so please use the protect function in the menu.

Common cautions for memory card

- Damaged data may not be recovered. It is recommended you make a back-up of important data on the hard disk of your PC.
- Turning the power off or removing a memory card during operations such as formatting, deleting, recording, and playback may cause data loss.
- After you modify the name of a file or folder stored in the memory card using your PC, your camcorder may not recognize the modified file.

Handling a memory card

- It is recommended that you power off before inserting or removing the memory card to avoid data loss.
- It is not guaranteed that you can use a memory card formatted by other devices. Be sure to format your memory card using this camcorder.
- You have to format newly-purchased memory cards, memory cards with data that your camcorder cannot recognize or are saved by other devices. Note that formatting erases all data on the memory card.
- If you cannot use a memory card that has been used with another device, format it with your camcorder. Note that formatting erases all information on the memory card.
- A memory card has a certain life span. If you cannot record new data, you have to purchase a new memory card.
- A memory card is a precision electronic media. Do not bend, drop, or cause strong impact to the card.
- Do not use or store at high temperatures, in humidity or a dusty environment.
- Do not bring foreign substances on the memory card terminals. Use a soft, dry cloth to clean the terminals if required.
- Do not paste anything other than the label supplied with the card on the label pasting portion.
- Be careful to keep the memory card out of the reach of children, who might swallow it.

about the storage media

The camcorder supports SDHC and MMCplus memory cards for data storage.

- The data storage speed may differ, depending on the manufacturer and production system.
- Using a lower write speed memory card when recording a movie may cause problems when storing the movie on the memory card. You may even lose your movie data during the recording.
- In an attempt to preserve every bit of the recorded movie, the camcorder forcibly stores the movie on the memory card and displays a warning: **"Low speed card. Please record a lower resolution."**

To facilitate movie recording, you are recommended to use a memory card that supports faster write speed.

- If you are forced to use a low speed memory card, resolution of the recording may be lower than the set value.
However, the higher the resolution, the more memory will be used.
- For optimal performance of the camcorder, ensure that you purchase a fast speed memory card.

Actual formatted capacity may be less as the internal firmware uses a portion of the memory.



- Samsung is not responsible for data loss due to misuse.
- We recommend using a memory card case to avoid losing data from moving and static electricity.
- After a period of use, the memory card may get warm. This is normal and is not a malfunction.

RECORDABLE TIME AND CAPACITY

- The following shows the camcorder's maximum recording time and number of images according to the resolution / memory capacity.
- For recording movie and photo images, please note the approximate maximum limits.

Recordable time for movie images

Media		Built-in memory*		Memory Card					
Capacity		8GB	16GB	1GB	2GB	4GB	8GB	16GB	32GB
TV Super Fine (4K)	720x480(60i)	190min.	380min.	23min.	47min.	95min.	190min.	380min.	760min.
TV Fine (HD)	720x480(60i)	240min.	480min.	30min.	60min.	120min.	240min.	480min.	960min.
TV Normal (HD)	720x480(60i)	310min.	620min.	38min.	77min.	155min.	310min.	620min.	1,240min.
Web Fine (HD)	640x480(30p)	240min.	480min.	30min.	60min.	120min.	240min.	480min.	960min.
Web Normal (SD)	640x480(30p)	310min.	620min.	38min.	77min.	155min.	310min.	620min.	1,240min.

(Unit: Approximate minutes of recording)

Recordable number of photo images

Media		Built-in memory*		Memory Card					
Capacity		8GB	16GB	1GB	2GB	4GB	8GB	16GB	32GB
Mode	Resolution								
4:3	800x600	9,999	9,999	1,920	3,840	7,680	9,999	9,999	9,999
	1600x1200	6,080	9,999	760	1,530	3,040	6,080	9,999	9,999
16:9	848x480	9,999	9,999	1,920	3,840	7,680	9,999	9,999	9,999
	1696x960	6,080	9,999	760	1,530	3,040	6,080	9,999	9,999

(Unit: Approximate number of images)

1GB= 1,000,000,000 bytes : actual formatted capacity may be less as the internal firmware uses a portion of the memory.

about the storage media



- The previous figures are measured under Samsung's standard recording test conditions and may differ depending on the test or use condition.
- The camcorder provides five resolution options for movie recordings:
 - **"TV Super Fine", "TV Fine", "TV Normal", "Web Fine", "Web Normal."**
 - **"TV Super Fine", "TV Fine"** and **"TV Normal"** modes provide optimal operation with a TV.
 - **"Web Fine"** and **"Web Normal"** modes provide optimal operation with web-based applications.
- The compression rate increases while lowering the resolution (in the order of **"TV Super Fine", "TV Fine", "TV Normal", "Web Fine", "Web Normal"**). The higher the compression rate is, the lower the resolution is, but the recording time will be increased.
- The compression rate automatically adjusts to the recording image, and the recording time may vary accordingly.
- You can use a SDHC or MMCplus memory card on your camcorder.
Some cards may not be compatible depending on the memory card manufacturer and memory card type.
- Proper operation is not guaranteed for those memory cards that are not formatted by this camcorder. Perform the formatting directly on the camcorder.
- To facilitate movie recording, it is recommended to use a memory card that supports faster write speed. (Write speed: 2MB / sec or higher) If you use a low write speed memory card, recording may stop with a message of **"Low speed card. Please record a lower resolution."**
- The camcorder will operate properly with memory cards up to 32GB for recording / playback. Memory cards bigger than **32GB** in capacity may not work properly.
- The memory card that is used to store a movie can cause unwritable areas, which may result in reduced recording time and free memory space.
- The maximum size of a movie (H.264/AVC) file that can be recorded at one time is 1.8GB.
- You can store up to 9999 movie and photo images in one folder.
- Movie (or photo) images recorded by other equipment are not playable on this camcorder.
- Items marked with * are available only with 8GB (SMX-C13 only), 16GB (SMX-C14 only) models.
- For recording, 16:9 aspect ratio will use more memory than 4:3 aspect ratio.
(You can select the desired LCD display aspect ratio for recording or playback (16:9 Wide/4:3 aspect ratio). See page 59)

recording

Basic procedures to record a movie or photo image are described below and on the following pages.

RECORDING MOVIE IMAGES

- The camcorder provides two **Recording start/stop** buttons. One is on the rear side of the camcorder and the other one is on the LCD panel. Select the one that works best for you.
- Open the LCD screen and press the **Power** (⊙) button to turn on the camcorder.
 - Connect a power source to the camcorder. ➔page 16
(A battery pack or an AC power adaptor)
 - Set the appropriate storage media. ➔page 38 (SMX-C13/C14 only)
(If you want to record on a memory card, insert the memory card.)
 - Check the subject on the LCD screen.
 - Press the **Recording start/stop** button.
 - The recording indicator (●) will display and recording will start.
 - To stop recording, press the **Recording start/stop** button again.
 - When recording is finished, turn the camcorder off.

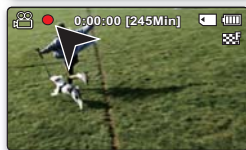
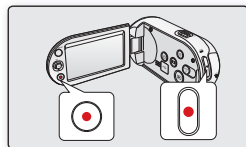

Quick View

Using the Quick View function, you can view the most recently recorded video or photo image right after your recording.

- Press the **OK** button in STBY mode right after your recording.
 - Shortcut menu (OK guide) is displayed on the LCD screen.
- Press the **Control** button (▶) to view the most recent video (or photo) you have recorded.
 - After the Quick view is finished, your camcorder switches back to the STBY mode.
 - During a Quick view, use the **Control** buttons (▲ / ▼ / ◀ / ▶/OK) for playback search or deleting the current file.

The Quick View function is not available in the following conditions:

- If the mode has been changed after the recording or the camcorder is connected USB cable.
- If the camcorder has been turned off and on again after the recording.



Do not disconnect the power source (battery pack, AC adaptor, etc) during recording. Otherwise, it may cause damage to the storage media or data corruption.



- For on-screen information display. ➔page 25
- Eject the battery pack when you have finished recording to prevent unnecessary battery power consumption.
- For various functions available when you record movie images. ➔pages 56~70
- During recording, some button operations are unavailable. (**Mode** (⊙) button, **MENU** button, etc.)
- Sound is recorded from the internal stereo microphone on the front of the camcorder. Take care that this microphone is not blocked.

recording

- Before recording an important movie, make sure to test the recording function to check if there is any problem with the audio and video recording.
- Do not operate the **Power** (⏻) button or remove the memory card while accessing the storage media. Doing so may damage the storage media or the data on the storage media.
- **This camcorder provides one combined movie and photo record mode.**
 - **You can easily record movies or photos in the same mode without having to change it. (SMX-C13/C14 only)**
- You cannot use a locked memory card for recording. You will see a message saying recording is disabled due to the lock.
- You can switch the play mode to the record mode by pressing the **Recording start/stop** or **Mode** (⏻) button.
- If the power cable/battery is disconnected or recording is disabled during recording, the system is switched to the data recovery mode. While data is being recovered, no other function is enabled. After data recovery, the system will be switched to the STBY mode. When the recording time is short, the data recovery might fail.

RECORDING WITH EASE FOR BEGINNERS (EASY Q MODE)

- With the EASY Q function, most of the camcorder settings are automatically adjusted, which frees you from detailed adjustments.
1. Open the LCD screen and press the **Power** (⏻) button to turn on the camcorder.
 2. Press the **EASY Q** button.
 - When you press the **EASY Q** button, most functions turn off and the following functions are set to **"Auto."** (Focus, iSCENE, etc.)
 - The EASY Q and **Anti-Shake(HDIS)** (👤) indicators appear on the screen at the same time.
 3. To record movie images, press the **Recording start/stop** button.
 - To take photo images, press the **PHOTO** (📷) button. (SMX-C13/C14 only)
 - Recording will begin using the basic automatic settings.

To cancel EASY Q mode

Press the **EASY Q** button again.

- The EASY Q and **Anti-Shake (HDIS)** (👤) indicators disappear from the screen.
- Most settings will return to the settings that were set prior to activating the EASY Q mode.

Unavailable buttons during EASY Q operation

- The following button and menu operations are unavailable because the items are automatically set. The corresponding message **"Release the EASY Q"** may appear if unavailable operations are attempted.
 - **MENU** button / **OK** button
- Cancel the EASY Q function if you want to add any effect or settings to the images.
- EASY Q mode settings are released when the camcorder is turned off.
- EASY Q mode automatically sets the **"Anti-Shake(HDIS)"** to **"On"** while using EASY Q.

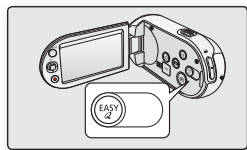

TAKING PHOTO IMAGES (SMX-C13/C14 ONLY)

- You can take photo images with the **PHOTO** (📷) button.
- Open the LCD Screen and press the **Power** (🔘) button to turn on the camcorder.
 - Set the appropriate storage media. ➡ page 38
(If you want to record on a memory card, insert the memory card.)
 - Check the subject on the LCD screen.
 - Press the **PHOTO** (📷) button.
 - Shutter sound is heard.
Indicators on the screen disappear, and the photo image is recorded.
 - While saving a photo image to the storage media, you cannot take the next photo.
 - When taking photo images is finished, turn the camcorder off.

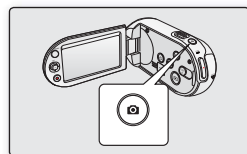

Quick View

Using the Quick View function, you can view the most recently recorded video or photo image right after your recording.

- Press the **OK** button in STBY mode right after your recording.
 - Shortcut menu (OK guide) is displayed on the LCD screen.
- Press the **Control** button (▶) to view the most recent photo (or video) you have recorded.
 - After the Quick view is finished, your camcorder switches back to the STBY mode.
 - During a Quick view, use the **Control** buttons (▲ / ▼ / ◀ / ▶ / OK) for playback search or deleting the current file.

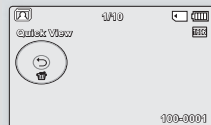

The Quick View function is not available in the following conditions:

- If the mode has been changed after the recording or the camcorder is connected USB cable.
- If the camcorder has been restarted after the recording.



- Audio will not be recorded with the photo image on the storage media.
- Do not turn off the camcorder or remove the memory card when taking photos as it may damage the storage media or data.
- Photo image files recorded by your camcorder conform to the "DCF (Design rule for Camera File system)" universal standard established by the JEITA (Japan Electronics and Information Technology Industries Association).
- DCF is an integrated image-file format for digital cameras: Image files can be used on all digital devices conforming to DCF.
- Available photo image resolutions are 1696X960 and 848X480 in 16:9 aspect ratio, while 1600X1200 and 800X600 are available in 4:3 aspect ratio. (To switch to 4:3, release 16:9 mode.) ➡ page 43
- This camcorder provides one combined movie and photo record mode. You can easily record movies or photos in the same mode without having to change it. (SMX-C13/C14 only)**
- You can switch the play mode to the record mode by pressing the **PHOTO** (📷) or **Mode** (⊖) button.

recording

ZOOMING IN AND OUT

Use the zoom function for close-up or wide-angle recording. This camcorder allows you to record using 10x optical power zoom and 1200x digital zoom.

- You can zoom with the zoom lever or the **Control** (W/T) button on the LCD panel.
- Zoom magnification over 10x is done through digital image processing, and is therefore called digital zoom. Digital zooming is possible up to 1200x. Set "**Digital Zoom**" to "**On.**" ➔page 67

To zoom in

- Slide the Zoom lever towards **T** (telephoto).
(Or press the **Control** button (▼) on the LCD panel.)

To zoom out

- Slide the Zoom lever towards **W** (wide-angle).
(Or press the **Control** button (▲) on the LCD panel.)



- The minimum possible distance between the camcorder and subject while maintaining sharp focus is about 5cm (about 1.96 inch) for wide-angle and 1m (about 39.4 inches) for telephoto.
- Optical zoom preserves image quality, but during digital zoom the image quality may suffer.
- Fast zooming or zooming in subject at a far distance may produce slow focusing. If this occurs, use "**Manual Focus.**" ➔page 62
- It is recommended to use "**Anti-Shake (HDIS)**" with handheld recording if the subject is zoomed in and enlarged.
- Frequent use of the zoom function consumes more power.
- The zooming speed of the zoom lever and zoom button are different. Use appropriately at your preference. For faster zooming adjustment, use the zoom lever. For slower zooming adjustment, use the zoom buttons.

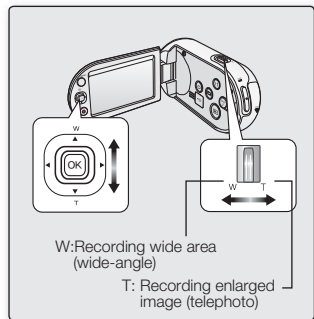

playback

- You can view recorded movie and photo images in thumbnail index view and play them in various ways.
- **This camcorder provides one combined movie and photo record mode. You can easily record movies or photos in the same mode without having to change it. (SMX-C13/C14 only)**

CHANGING THE PLAYBACK MODE (SMX-C13/C14 ONLY)

- Pressing the **Mode** (Ⓢ) button changes the operation mode to Record (📹) and Video/Photo Play (📺, 📷) mode in turn.
- The recorded movie and photo images are displayed in thumbnail index view. According to the previous record mode, recordings will be stored in Movie images and Photo images thumbnail index view, respectively. When switching to Play mode after recording in Movie Record mode, The Movie images thumbnail index view appears. When switching to Play mode after recording in Photo Record, the photo images thumbnail index view appears.

How to change the operation modes

- You can simply switch between video and photo thumbnail view as follows: Press the **Mode** (Ⓢ) button → **MENU** button and then use the **Control** button (▲ / ▼ / ◀ / ▶ / OK) to select "**Play Mode**" → "**Video**" or "**Photo**" in menu option.
- You can also simply switch between video and photo thumbnail view using the zoom lever.
- Setting the Play Mode menu is available in thumbnail view only.

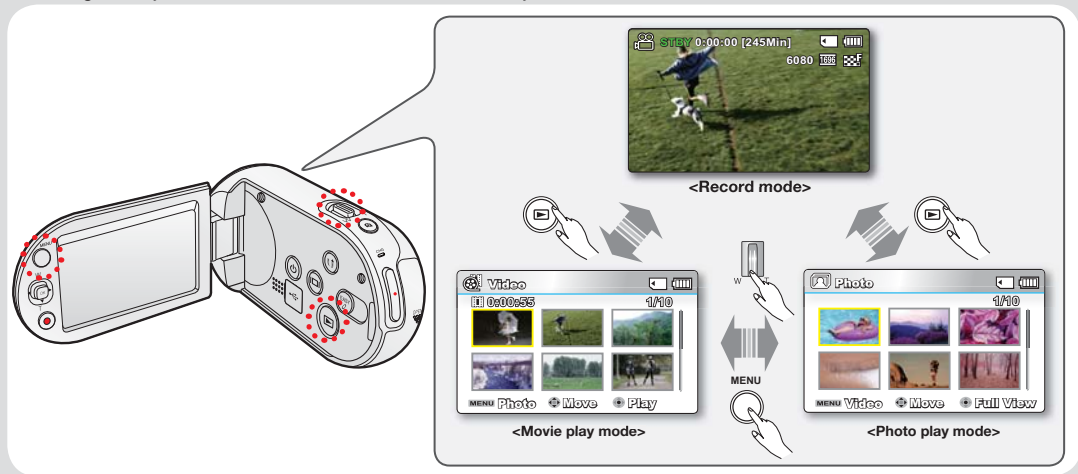

playback

PLAYING MOVIE IMAGES

- This function works only in Movie Play mode.
 - You can find a desired movie image quickly using the thumbnail index view.
1. Open the LCD Screen and press the **Power** (⏻) button to turn on the camcorder.
 - Set the appropriate storage media. (SMX-C13/C14 only)
(If you want to playback images on a memory card, insert the memory card.)
 2. Press the **Mode** (Ⓜ) button to select the Play mode.
 - The thumbnail index view appears. The thumbnail highlight is on the latest created or played file.
 - Playing time of the selected file and the thumbnail showing the movie playback will appear on the screen.
 3. Set the Play Mode to **“Video”**. (SMX-C13/C14 only)
 - Press the **MENU** button. Use the **Control** button to select **“Play Mode”** → **“Video”**.
 - You can also simply switch between video and photo thumbnail view using the zoom lever.
 4. Use the **Control** button (▲ / ▼ / ◀ / ▶) to select the desired movie images, and then press the **OK** button.
 - Shortcut menu for playback will be displayed.
 - The selected movie images are played according to the Play Option setting.
▶ page 72
 - To stop playback and return to the thumbnail index view, move the zoom lever.

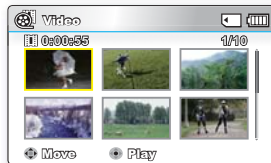
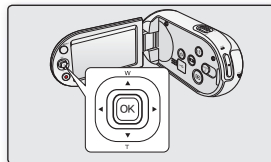
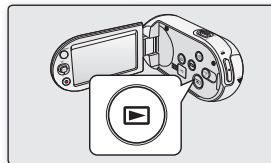

- If there is no file stored to view, the message "**Empty**" appears.
- When the LCD screen is closed during playback, the built-in speaker automatically turns off.
- Movie files may not playback on the camcorder in the following cases:
 - Movie files edited or renamed on a PC
 - Movie files recorded by devices other than the camcorder
 - Movie file formats that are supported
- The built-in speaker automatically turns off when the Audio/Video cable is connected to the camcorder. (When connected to external devices, volume adjustment should be done on the connected external device.)
- You can playback recorded movie files on a TV or a PC. ➡pages 96, 106
- You can upload recorded movies or photos to YouTube or Flickr using Intelli-studio. ➡page 101
- For various functions available during playback, see "playback options." ➡pages 71~83
- Use the Quick View function if you want to preview the last recorded movie or photo images. ➡page 34

Adjusting the volume

Press the **Control** button (▲ / ▼) to increase or decrease the volume.

- The volume bar disappears after 3~4 seconds.
- You can hear the recorded sound from the built-in speaker.
- The level can be set to anywhere between 0 and 10.
(If you close the LCD screen while playing, you will not hear the sound from the speaker.)
- The volume bar does not appear when Audio/Video cable jack is inserted.



playback

Various Playback Operations

Still playback (pause) (▶/||)

- Press the **OK** button during playback.
 - To resume normal playback, press the **OK** button again.

Search playback (◀/▶)

- During playback, press and hold the **Control** button (▶) for forward search, or to the left for reverse search.
- Pressing the **Control** button to (◀/▶) repeatedly increases the search speed for each direction.
 - RPS (Reverse Playback Search) rate: x2→x4→x8→x16
 - FPS (Forward Playback Search) rate: x2→x4→x8→x16
- To resume normal playback, press the **OK** button.

Skip playback (I◀/▶I)

- During playback, press the **Control** button (▶) to locate the start point of the next file. Pressing the **Control** button (▶) repeatedly skips files in the forward direction.
- During playback, press the **Control** button (◀) to locate the start point of the current file. Pressing the **Control** button (◀) repeatedly skips files in the reverse direction.
- Press the **Control** button (◀) within 3 seconds from the start point, and the first image of the previous file is skipped.

Frame-by-frame playback (||▶)

- During pause, pressing the **Control** button (▶) makes play go forward one frame at a time.
 - To resume normal playback, press the **OK** button.

Slow motion playback (I▶)

- During pause, holding the **Control** button (▶) reduces the playback speed.
- During slow motion playback, pressing the **Control** button (▶) changes the playback speed.
 - Forward slow playback rate: x1/2 → x1/4 → x1/8 → x1/16
 - To resume normal playback, press the **OK** button.
- Recorded sound is not heard in slow playback.

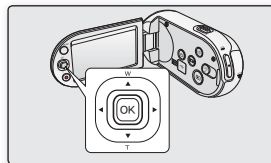

VIEWING PHOTO IMAGES (SMX-C13/C14 ONLY)

- This function works only in Photo Play mode.
- You can find and view desired photo images quickly using the thumbnail index view.

1. Open the LCD screen and press the **Power** (⏻) button to turn on the camcorder.
 - Set the appropriate storage media. ➡ page 38
(If you want to playback images on a memory card, insert the memory card.)
2. Press the **Mode** (⊞) button to select the Play mode.
 - The thumbnail index view appears. The thumbnail highlight is on the latest created or played file.
3. Set the Play Mode to **“Photo.”**
 - Press the **MENU** button. Use the **Control** button to select **“Play Mode”** → **“Photo.”**
 - You can also simply switch between video and photo thumbnail view using the zoom lever.
4. Use the **Control** button (▲ / ▼ / ◀ / ▶) to select the desired photo images, and then press the **OK** button.
 - Shortcut menu for playback will be displayed.
 - To view the previous/next photo, press the **Control** button (◀ / ▶).
 - To return to the thumbnail index view, move the zoom lever.

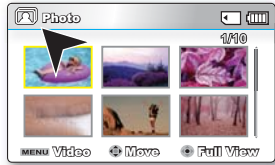
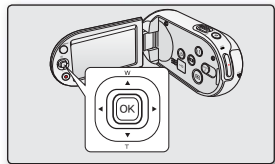
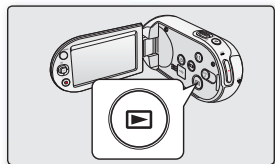

- Do not power off or eject the memory card during photo playback. Doing so may damage the recorded data.
- Your camcorder may not playback the following photo files normally:
 - A photo with its file name changed on a PC.
 - A photo recorded on other devices.
 - A photo with a file format not supported on this camcorder (does not conform to DCF standards).



- Loading time may vary depending on the size and quality of the selected photo.
- The Quick View function is used if you want to preview the last recorded photo images. ➡ page 47

recording options

CHANGING THE MENU SETTINGS

You can change the menu settings to customise your camcorder. Access the desired menu screen by following the steps below, then change the various settings.

1. Open the LCD Screen and press the **Power** (⏻) button to turn on the camcorder.
2. Press the **MENU** button.
 - The menu screen appears.
3. Select the desired submenu and menu item with the **Control** buttons (▲ / ▼ / ◀ / ▶) and the **OK** button.
 - To return to the normal screen, press the **MENU** button.
 - Depending on the mode selected, some menu items may not be available to select and change.



You can also access the shortcut menu using the **OK** button. ➡ page 33

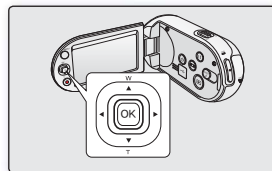
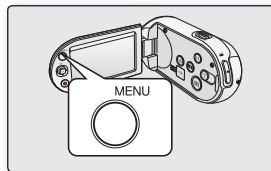

Button Tips

- a. **MENU** button : Use it to enter or exit the menu.
- b. **Control** button (▲ / ▼ / ◀ / ▶) : Use it to move up/down/left/right
- c. **OK** button : Use it to select or confirm the menu.

★ Follow the instructions below to use each of the menu items listed after this page.

For example: Setting the iSCENE in Record mode.

1. Open the LCD Screen and press the **Power** (⏻) button to turn on the camcorder.
2. Press the **MENU** button.
 - The menu screen appears.
3. Press the **Control** button (◀ / ▶) to select "**iSCENE.**"
4. Select the desired submenu item with the **Control** button (▲ / ▼), and then press the **OK** button.
5. Press the **MENU** button to exit the menu.



The selected item is applied and the indicator is displayed. However, if "**Auto**" is selected in the iSCENE mode, the item's indicator may not be displayed on the screen. (iSCENE, Back Light, Focus, etc.)

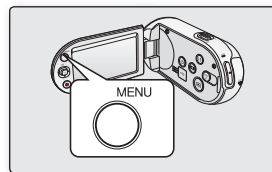

recording options

MENU ITEMS

- Accessing items in the menu depends on the operation mode.
- For operation details, see the corresponding page. ➡ pages 57–70

Recording menu items

● : Possible

Items	Record (📹) mode	Default value	Page
iSCENE	●	Auto	57
Video Resolution	●	TV Fine	58
Photo Resolution *	●	1696x960(16:9 Wide)	59
16:9 Wide	●	On	59
EV	●	0	60
Back Light	●	Off	61
Focus	●	Auto	62
Anti-Shake (HDIS)	●	Off	64
Digital Effect	●	Off	65
Fader	●	Off	66
Wind Cut	●	Off	66
Digital Zoom	●	Off	67
Time Lapse REC	●	Off	68
Guideline	●	Off	70
Settings	●	-	85



Items marked with * are available with models SMX-C13/C14 only.















USING THE RECORDING MENU ITEMS

You can the menu items for movie or photo images recording.

iSCENE

This camcorder automatically sets the shutter speed and aperture according to the subject brightness for optimum recording:

You can also specify one of various modes depending on subject conditions, recording environment or purpose of filming.

item	contents	on-screen display
"Auto"	- You can shoot images in Auto adjustment mode.	None
"Sports"	- Reduces blurring when recording rapidly moving subjects such as in golf or tennis. If the Sports mode is used under a fluorescent light, the image may flicker. In this case, use the Auto mode for recording.	
"Portrait"	- Creates a shallow depth of field so that the person or subject appears against a softened background. - The portrait mode is most effective when used outdoors. - EV value is automatically adjusted to the optimal.	
"Spotlight"	- Prevents overexposure of subject's face, etc. when strong light strikes the subject, as in a wedding or on stage.	
"Beach"	- Where sunlight is intense like a beach.	
"Snow"	- Where reflection of light is intense like a snowfield.	
"High Speed"	- Reduces blurring objects in rapid motion.	
"Food"	- Recording close-up objects in high saturation.	
"Waterfall"	- Recording a waterfall or fountain.	
"Daylight"	- Recording in broad daylight.	
"Cloudy"	- Recording under cloudy weather.	
"Fluorescent "	- Recording under white fluorescent lamp.	
"Tungsten"	- Recording under white tungsten lamp.	
"Night"	- Recording under low light.	
"Darkness"	- Recording under extremely low light.	

recording options



- You can check the selected iSCENE on the on-screen information display. However, nothing will appear in **"Auto"** mode.
- The iSCENE also can be set in the shortcut menu. ➔page 33



Video Resolution

You can select the resolution of a movie to be recorded. This camcorder can record in **"TV Super Fine"**, **"TV Fine"**, **"TV Normal"**, **"Web Fine"** and **"Web Normal"** modes. The **"TV Fine"** mode is set as the factory default.





item	contents	on-screen display
"TV Super Fine"	Movie images recorded in 720x480(60i) resolution at super-fine image quality.	
"TV Fine"	Movie images recorded in 720x480(60i) resolution at fine image quality.	
"TV Normal"	Movie images recorded in 720x480(60i) resolution at normal image quality.	
"Web Fine"	Movie images recorded in 640x480 (30p) resolution at fine image quality. Supports viewing with the optimal resolution on a PC.	
"Web Normal"	Movie images recorded in the 640x480 (30p) resolution at normal image quality. Supports viewing with the optimal resolution on a PC.	



- You can record a scene at five resolution levels: **"TV Super Fine"**, **"TV Fine"**, **"TV Normal"**, **"Web Fine"** or **"Web Normal."** However, the better the resolution is, the more memory is used.
- The recording times depend on the resolution of a movie to be recorded. ➔page 43

Photo Resolution

You can select the resolution of the photo image to be recorded. For detailed information image capacity. ➡page 43

item	contents	on-screen display
1696x960 (16:9)	Records in 1696x960 resolution.	
848x480 (16:9)	Records in 848x480 resolution.	
1600x1200 (4:3)	Records in 1600x1200 resolution.	
800x600 (4:3)	Records in 800x600 resolution.	



- For photo development, the higher the resolution, the finer the image quality.
- The number of recordable images varies depending on the recording environment.
- High resolution images occupy more memory space than low resolution images. If a higher resolution is selected, there is less space to store photos in the memory.
- The submenu items of Photo Resolution vary depending on the selection of the 16:9 Wide function.

16:9 Wide

You can select the desired LCD display aspect ratio for recording or playback (16:9 Wide/4:3 aspect ratio).

item	contents	on-screen display
"Off"	Disables the function. Displays the image in 4:3 aspect ratio. Select to use the standard display aspect ratio of 4:3 on the screen.	None
"On"	Recording and viewing of 16:9 aspect ratio.	None



- In **"16:9 Wide"** mode, you cannot use the following functions : **"Mosaic"**, **"Mirror"**, **"Step printing"** (Digital Effect). If you want to use the following functions, set the **"16:9 Wide"** menu to **"Off"** first.
- Please set the aspect ratio before recording. The default setting is **"16:9 Wide."**

recording options

EV (Exposure Value)

The camcorder usually adjusts the exposure automatically.

You can also manually adjust the exposure depending on the recording conditions.

Setting the exposure manually:

When manually setting the exposure, the default setting appears as the value is automatically adjusted according to the environmental light conditions.

- Press the **Control** button (◀ / ▶) to adjust the exposure while viewing the image on the LCD screen.
 - Confirm your selection by pressing the **OK** button.
 - Exposure value can be set between **"-2.0"** and **"+2.0"**
 - If you set exposure to manual, the higher the exposure, the brighter the recorded picture will be.
 - Exposure value setting will be applied and (☑ XX) indicator and setting value are displayed.
- **Manual exposure is recommended in situations:**
 - When shooting using reverse lighting or when the background is too bright.
 - When shooting against a reflective natural background such as at the beach or when skiing.
 - When the background is overly dark or the subject is bright.



- The exposure also can be set in the shortcut menu. ➡ page 34
- The shutter speed also varies automatically depending on the EV value.

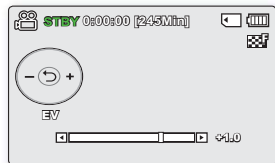
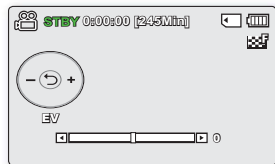
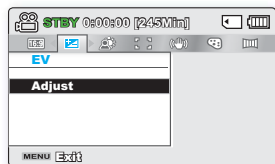

Back Light

When the subject is lit from behind, this function will compensate for lighting so that the subject is not too dark.

item	contents	on-screen display
"Off"	Disables the function.	None
"On"	- Backlight compensation is executed. - Backlight compensation brightens the subject quickly.	

Back lighting influences recording when the subject is darker than the background:

- The subject is in front of a window.
- The subject is against a snowy background.
- The subject is outdoors and the background is overcast.
- The light sources are too bright.
- The person to be recorded is wearing white or shiny clothes and is placed against a bright background:
The person's face is too dark to distinguish his/her features.



<Backlight off>





<Backlight on>

recording options

Focus

- The camcorder usually focuses on a subject automatically (auto-focus).
- You can also manually focus on a subject depending on the recording conditions.



item	contents	on-screen display
"Auto"	In most situations, it is better to use the automatic focus feature, as it enables you to concentrate on the creative side of your recording.	None
"Face Detection"	Records under the optimal condition by detecting faces automatically.	
"Manual"	Manual focusing may be necessary under certain conditions that make automatic focusing difficult or unreliable.	

Face detection

It detects and recognizes face-like shapes and adjusts focus, color and exposure automatically. Also, it adjusts recording conditions optimised for the face detected.

- Press the **Control** button (▲ / ▼) to select "**Face Detection**", and then press the **OK** button.
 - Detects a face and shows a frame on it. The detected face image is optimised automatically.



- The Face Detection indicator () and Face Detection frame () are not recorded.
- Framing a person's face while Face Detection is set will adjust focus and exposure to optimal values automatically.
- Face Detection may not operate depending on the recording conditions. For example, the Face Detection Frame may appear when framing a "face-like" shape, even when the subject is not a person's face. If this occurs, turn off the Face Detection feature.
- The Face Detection feature will not work when framing the side of a person's face. You must be facing them "head-on."
- Face Detection will not work in "**Web Fine**" and "**Web Normal**" modes.

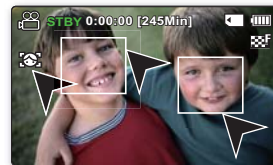
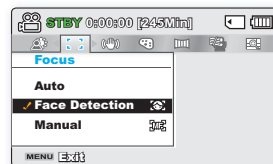

Focusing manually during recording:

This camcorder automatically focuses a subject from close-up to infinity. However, the correct focus may not be obtained depending on the recording conditions. In this case, use the manual focus mode.

1. Press the **Control** button (▲ / ▼) to select **"Manual."**
 - The manual focus adjustment indicator appears.
2. Press the **Control** button (◀ / ▶) to select the desired indicator to adjust focus, then press the **OK** button.



Focusing on a nearer subject

To focus on a nearer subject, press the **Control** button (◀).

Focusing on a farther subject

To focus on a farther subject, press the **Control** button (▶).

- The nearer or farther icon (◀ / ▶) appears between the indicators when focus adjustment reaches the end.
- The adjusted value is applied right after pressing the **Control** button (◀ / ▶) to adjust the focus.
- The manual focus setting will be applied and the (MF) indicator is displayed.



<Nearer subject >



<Further subject >

Manual focus is recommended in the following situations :

- A picture containing several objects, some close to the camcorder, others further away.
- A person enveloped in fog or surrounded by snow.
- Very shiny or glossy surfaces like a car.
- People or objects moving constantly or quickly like an athlete or a crowd.



- You can easily adjust the focus using the Shortcut menu button. ➡page 34
- Manual focusing focuses on a point in the framed scene while auto focusing focuses on the center area automatically.
- Use the zoom function to catch the desired target before manually adjusting the focus. If you use the zoom function after manual focusing, refocusing is required.
- Before focusing manually, check if the **"Digital Zoom"** is turned off. When **"Digital Zoom"** is turned on, manual focusing will not focus with accuracy. Turn the **"Digital Zoom"** off. ➡page 67

recording options

Anti-Shake (HDIS)

When you use zoom to record a magnified subject image, it will correct fuzziness in the recorded image.

item	contents	on-screen display
"Off"	Disables the function.	None
"On"	Compensates for unstable images caused by camcorder-shake, particularly at high magnification.	

Anti-Shake (HDIS) provides a more stable image when:











- Recording while zooming
- Recording small objects
- Recording while walking or moving
- Recording through the window of a moving vehicle





- EASY Q mode automatically sets "**Anti-Shake(HDIS)**" to "**On.**"
- When "**Anti-Shake (HDIS) : On**" is specified, there will be a slight difference between the actual movement and the movement on screen.
- Large camcorder shake may not be entirely corrected even if "**Anti-Shake (HDIS) : On**" is specified. Firmly hold the camcorder with both hands.
- It is recommended that you specify "**Anti-Shake (HDIS): Off**" when using the camcorder on a desk or tripod.
- When you record pictures with 10x or more magnification and the "**Anti-Shake (HDIS)**" is "**On**" in dim places, after-images may stand out. In this case, we recommend using a tripod and turning the "**Anti-Shake (HDIS)**" to "**Off.**"

Digital Effect

- The digital effect enables you to give a creative look to your recording.
- Select the appropriate digital effect for the type of picture that you wish to record and the effect you wish to create.
- There are 10 different digital effect options.

item	contents	on-screen display
"Off"	Disables the function.	None
① "BLK&WHT"	Changes the images into Black and White.	
② "Sepia "	This mode gives the images a reddish brown pigment.	
③ "Negative"	Reverses the colors and the brightness, creating the look of a negative.	
④ "Art"	Adds artistic effects to an image.	
⑤ "Emboss"	This mode creates a 3D effect (embossing).	
⑥ "Mosaic"	A mosaic overlay appears on an image.	
⑦ "Mirror"	This mode cuts the image in half and makes a mirrored image on the other half.	
⑧ "Pastel"	This mode applies a pale pastel drawing effect to an image.	
⑨ "Cosmetic"	This mode helps correct facial imperfections.	
⑩ "Step printing"	Technique of recording the image in segments.	





























recording options

Fader

You can give your recording a professional look by using special effects such as fade in at the beginning of a sequence or fade out at the end of a sequence.

item	contents	on-screen display
"Off"	Disables the function.	None
"In"	As soon as you start recording, the fader will be executed.	
"Out"	When the recording is done, the fader will be executed.	
"In-Out"	When you start or stop recording, the fader will be executed accordingly.	

Fade in

Press the **Recording start/stop** button when **"Fader"** is set to **"In."** Recording starts with a dark screen and then the image and sound are faded in.

Fade out

Press the **Recording start/stop** button when **"Fader"** is set to **"Out."** Recording stops as the image and sound are faded out.

Fade in-out

Press the **Recording start/stop** button when **"Fader"** is set to **"In-Out."** Recording starts with a dark screen and then the image and sound are faded in and recording stops as the image and sound are faded out.

Fade In (Approx. 3 seconds)



Fade Out (Approx. 3 seconds)



This function is disabled after being used one time.

Wind Cut

You can reduce wind noise when recording sound from the built-in microphone.

If **"Wind Cut : On"** is set, the low-frequency components in the sound picked up by the microphone will be cut off during recording: This makes it easier to hear voice and sound during playback.

- Use Wind Cut when recording in windy places such as a beach.

item	contents	on-screen display
"Off"	Disables the function	None
"On"	Minimizes wind noise or other noise while recording.	



When **"Wind Cut"** is **"On"**, some low frequency sound is eliminated along with the sound of the wind.

Digital Zoom

- You can select the maximum zoom level in case you want to zoom to a level greater than 10x (the default setting) during recording. Up to 10x zoom is performed optically, and after that, up to 1200X zoom is performed digitally. Note that the image quality decreases when you use the digital zoom.

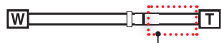

This right side of the bar shows the digital zooming zone.
The zooming zone appears when you move the zoom lever.

item	contents	on-screen display
"Off"	Only optical zoom is available up to 10x.	None
"On"	Digital zoom is available up to 1200x. Moving the zoom lever will display the digital zoom bar.	None



- The image quality may deteriorate depending on how much you zoom in on the subject.
- Maximum zooming may result in lower image quality.

recording options

Time Lapse REC

- Time Lapse REC records still images at specific intervals you can set, and plays them as one movie file.
- This function is useful for observing the movement of clouds, the changes in daylight or blooming flowers, etc.

Settings	Contents	On-screen display
"Off"	Disables the function.	None
"On"	When you start movie recording, images of the subject are captured and saved to the storage media by set interval and total recording period.	

Setting the Time Lapse REC mode:

To record in the Time Lapse REC mode, you need to set the recording interval and total recording time in the menu.

1. Press the **MENU** button.
2. Press the **Control** button (◀ / ▶) to select **"Time Lapse REC."**
3. Press the **Control** button (▲ / ▼) to select **"On"**, then press the **OK** button.
 - The recording interval and total time for recording items are displayed.
("Sec": seconds, "Hr": hours)
4. Set a desired recording interval ("Sec") with the **Control** button (▲ / ▼).
5. Move to the next setting with the **Control** button (◀ / ▶) and set a desired total recording time ("Hr") in the same way.
 - While you set the preparatory settings (recording interval and total recording time), the approximate time-lapse recording time will be displayed on the menu screen.
6. Press the **OK** button to finish the setting and press the **MENU** button to exit the menu.
7. After setting the Time Lapse REC mode, press the **Recording start/stop** button. The Time Lapse REC starts.
 - While playing back, it will display 30 images per second. (Sound is not available.)
For example, if the recording interval was **"30"** seconds and the total recording time was **"24"** hours, images are automatically captured and saved in the storage media every 30 second for 24 hours. (After 24 hours of recording, playback will last for about **"1Min 36 Sec"** (96 seconds).)

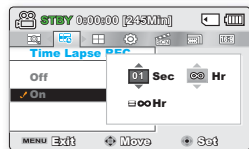
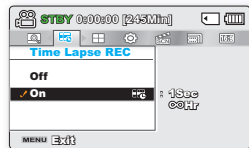

Example of Time Lapse REC

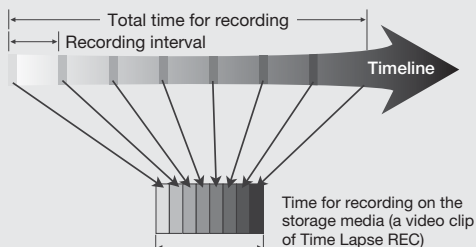

Time Lapse REC records image frames at a predefined interval to produce a time-lapse video.

Time Lapse REC is useful for filming in the following situations:



- Blooming flowers
- Insect's skin-casting
- Clouds rolling by in the sky

- This function is disabled after being used one time.
- 30 captured images compose a video of 1 second length. Since the minimum length of a video to be saved by your camcorder is one second, the interval defines how long the Time Lapse Recording should be set for. For example, if you set the interval to "30 Sec," Time Lapse Recording should be set for at least 15 minutes to record a minimum video length of 1 second (30 images).
- Once the Time Lapse REC finishes recording for its total recording time, it switches to standby mode.
- Press the **Recording start/stop** button if you want to stop the Time Lapse REC.
- Audio is not recorded during Time Lapse Recording.
- When a video recording fills up 1.8GB of storage media, a new recording file is automatically started at that point.
- When the battery is discharged exhausted during Time Lapse REC, it saves recording up to that point and switches to standby mode. After a while, it displays a warning message, then turns off automatically.
- When memory runs out while performing Time Lapse REC, the camcorder switches to standby mode after saving what was recorded so far.
- We recommend using the AC power adaptor when using the Time Lapse REC function.
- When a time lapse recording starts, a message of "Time Lapse Recording" blinks on the screen and it appeared to be as if the screen is stopped. This is a normal operation; do not remove the power source or memory card from the camcorder.

recording options

Guideline

- Guideline displays a certain pattern on the LCD screen so that you can easily set the image composition when recording images.
- The camcorder provides 3 types of guidelines.

item	contents	on-screen display
"Off"	Disables the function.	None
"Cross"	Records the subject placed in the center.	
"Grid"	Records the subject on the horizontal or vertical composition or close-up.	
"Safety Zone"	Records the subject within safety zone which prevents them from being cut when editing in 4:3 for left and right and 16 x9 (2.35:1) for top and bottom. Set " Safety Zone " when you want to have various subjects in one scene with the proper size.	



- Positioning the subject at the cross point of the guideline provides a balanced composition.
- Guideline cannot be recorded on the images being recorded.



playback options

MENU ITEMS

- Accessible items in the menu vary depending on the operation mode.
- See pages 49-53 for playback information and button operation.
- See pages 71-83 for details on menu items during playback.

Playback menu items

● : Possible
× : Not possible

Items	Movie Play ()	Photo Play * ()	Default value	Page
Play Mode *	●	●	Video	9
Play Option	●	×	Play All	72
Delete	●	●	-	73
Protect	●	●	-	74
Story-Board Print	●	×	-	75
Copy *	●	●	-	76
Edit	Divide	×	-	78
	Combine	×	-	80
Share Mark	●	×	-	81
Slide Show *	×	●	-	82
File Info (Full image display mode only)	●	●	-	83
Settings	●	●	-	84



- Items marked with * are available only with SMX-C13/C14 models.
- The photo function is available only with SMX-C13/C14 models.

playback options

PLAY OPTION

You can set a specific playback style according to your preference.

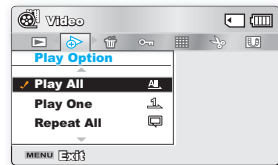

item	Contents	on-screen display
"Play All"	Plays back from the selected movie to the last movie.	
"Play One"	The selected movie will be played.	
"Repeat All"	All movies will be played repeatedly.	
"Repeat One"	The selected movie will be played repeatedly.	

DELETE

You can erase your recordings one by one, or all at once.

1. Open the LCD Screen and press the **Power** (⏻) button to turn on the camcorder.
 - Set the appropriate storage media. (SMX-C13/C14 only)
(If images were recorded on a memory card, insert the memory card.)
2. Press the **Mode** (⊙) button to select the Play mode.
 - Set the Play Mode to "**Video**" or "**Photo**."
Press the **MENU** button and then use the **Control** button (▲/▼/◀/▶/OK) to select "**Play Mode**" → "**Video**" or "**Photo**." (SMX-C13/C14 only)
3. Press the **MENU** button → **Control** button (◀/▶) to select "**Delete**."
4. Select an option by pressing the **Control** button (▲/▼) and then press the **OK** button.

item	contents
"Select Files"	Deletes individual selected movie (or photo) images. <ul style="list-style-type: none">- To delete individual movie (or photo) images, select the desired movie (or photo) images to delete by pressing the OK button, then press the MENU button to delete.- The indicator (🔒) is displayed on the selected movie (or photo) images.- Pressing the OK button toggles the selection and release.
"All Files"	Deletes all movie (or photo) images.

5. The pop-up selection menu will appear depending on the selected menu item.
In this case, select the desired item with the **Control** buttons (◀/▶) and the **OK** button.



- Note that removing the battery pack or disconnecting the AC power adaptor while you delete files may damage the storage media.
- To protect important images from accidental deletion, activate the image protection. ↪page 74
- The protect (🔒) indicator will blink if you try to delete an image that was previously protected. ↪page 74
- You must release the protect function to delete the image.
- If the write protection tab on the memory card is set to lock, you cannot delete. ↪page 40
- You can also format the storage media to delete all the images at once.
- Be aware that all files and data including protected files will be erased.
- The photo function is available only with SMX-C13/C14 models.

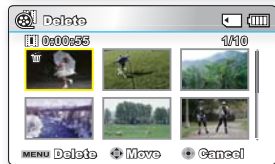
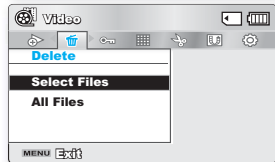
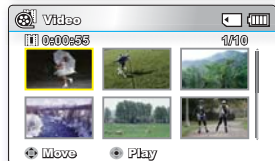
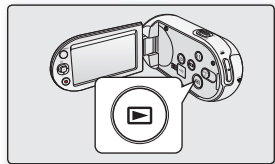

playback options

PROTECT

- You can protect saved important movie (or photo) images from accidental deletion.
 - Protected images will not be deleted unless you release the protection or format the memory.
1. Open the LCD Screen and press the **Power** (⏻) button to turn on the camcorder.
 - Set the appropriate storage media. (SMX-C13/C14 only)
(If images were recorded on a memory card, insert the memory card.)
 2. Press the **Mode** (⊙) button to select the Play mode.
 - Set the Play Mode to **"Video"** or **"Photo."**
Press the **MENU** button and then use the **Control** button (▲/▼ / ◀/▶/OK) to select **"Play Mode"** → **"Video"** or **"Photo."** (SMX-C13/C14 only)
 3. Press the **MENU** button → **Control** button (◀/▶) to select **"Protect."**
 4. Select an option by pressing the **Control** button (▲/▼) and then press the **OK** button.

item	contents
"Select Files"	Protects selected movie (or photo) images from deletion - To protect individual movie (or photo) images, select the desired movie (or photo) images by pressing the OK button, then press the MENU button to confirm. - The indicator (Ⓜ) is displayed on the selected movie (or photo) images. - Pressing the OK button toggles the selection between protection and release.
"All On"	Protects all movie (or photo) images.
"All Off"	Cancels the protection for all movie (or photo) images.

5. The pop-up selection menu will appear depending on the selected menu item.
In this case, select the desired item with the **Control** buttons (◀/▶) and the **OK** button.



- Protected movie (or photo) images will show the indicator (Ⓜ) when they are displayed.
- If the write protection tab on the memory card is set to lock, you cannot set image protection.
- The photo function is available only with SMX-C13/C14 models.

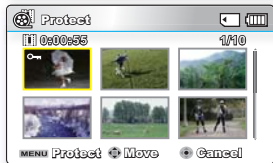
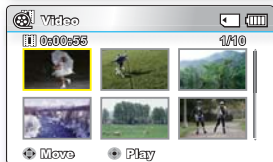
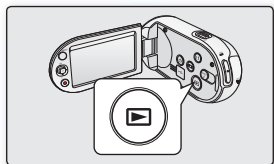

STORY-BOARD PRINT

This function captures 16 still images arbitrarily from the selected movie and saves them into the storage media. It presents a quick overview of your movie, helping you to understand the overall topic.

1. Open the LCD Screen and press the **Power** (⏻) button to turn on the camcorder.
 - Set the appropriate storage media. (SMX-C13/C14 only)
(If images were recorded on a memory card, insert the memory card.)
2. Press the **Mode** (⊞) button to select the Play mode.
 - Set the Play Mode to **"Video."**
Press the **MENU** button and then use the **Control** button (▲ / ▼ / ◀ / ▶ / OK) to select **"Play Mode"** → **"Video."** (SMX-C13/C14 only)
3. Press the **MENU** button → **Control** button (◀ / ▶ / OK) to select **"Story-Board Print"** → **"Select File."**
4. Use the **Control** button (▲ / ▼ / ◀ / ▶) to select the desired movie images, and then press the **OK** button.
 - A message appears asking for your confirmation.
5. Select **"Yes."**
 - Images to be captured are selected arbitrarily, and compose a storyboard of 16 images.
 - The saved storyboard can be found in the storage media's DCIM folder, using a computer. ➡page 106
 - You can also find the saved storyboard image in the photo playback display. (SMX-C13/C14 only) ➡page 53



Storyboard images are displayed in 4:3 aspect ratio. Hence, it may not display the entire image on the LCD screen. On a computer, it will display the entire image.

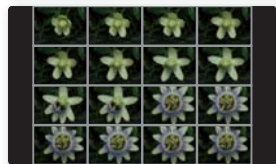
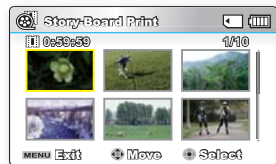
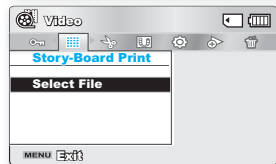
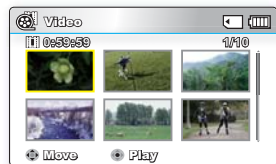

playback options

COPY (SMX-C13/C14 ONLY)

- Images are copied to the destination storage while original images are left in the source storage.
- It copies from the currently used memory to another. For example, if the built-in memory was used, it copies to a memory card.

1. Open the LCD Screen and press the **Power** (Ⓞ) button to turn on the camcorder.
 - Set the appropriate storage media. (Insert a memory card.)
2. Press the **Mode** (Ⓢ) button to select the Play mode.
 - Set the Play Mode to **"Video"** or **"Photo"**.
Press the **MENU** button and then use the **Control** button (▲ / ▼ / ◀ / ▶ / OK) to select **"Play Mode"** → **"Video"** or **"Photo."** (SMX-C13/C14 only)
3. Press the **MENU** button → **Control** button (◀ / ▶) to select **"Copy."**
4. Select an option by pressing the **Control** button (▲ / ▼) and then press the **OK** button.

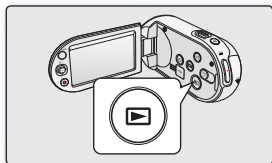

item	contents
"Select Files"	<p>Copies the individual movie (or photo) images.</p> <ul style="list-style-type: none">- To copy individual movie (or photo) images, select the desired movie (or photo) images by pressing the OK button.- The indicator (👉) is displayed on the selected movie (or photo) images, then press the MENU button to confirm.- Pressing the OK button toggles between selecting and releasing the copy function.
"All Files"	Copies all the movie (or photo) images.

5. The pop-up selection menu will appear depending on the selected menu item. In this case, select the desired item with the **Control** buttons (◀ / ▶) and the **OK** button.
 - Images are copied in another storage media.

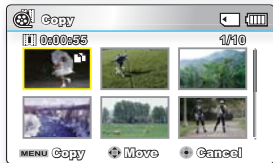
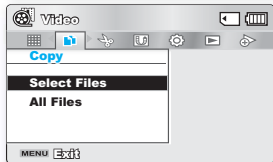
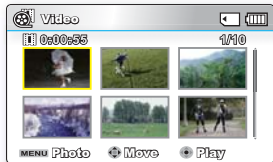

- 
- In general, use of functions both in thumbnail display and full image display employs the same method, while their detailed options may be different.
 - If a memory card is not inserted, you cannot perform the **"Copy"** function.
 - If free space available on the storage is insufficient, copying may not be possible. Delete unnecessary images. ➡ page 73
 - Copied movie (or photo) images have no protection even if the original is set to be protected.
 - Copying may take a while depending on the number of files and file size.
 - Copying may not operate if the battery charge is insufficient. If available, use the AC adaptor while copying to prevent power disconnection.
 - Note that removing the battery pack or disconnecting the AC power adaptor while you copy files may damage the storage media.
 - Follow the same instructions to copy video clips (or photos) from a memory card to the built-in memory. Before using this function, select the storage media that contains the desired videos (or photos) to be copied.
 - The photo function is available only with SMX-C13/C14 models.

playback options

DIVIDE

- This function works only in Play mode. ↪page 49
 - You can divide a movie image as many times as you want in order to delete a section you no longer need. The movie images will be divided in groups of two.
1. Open the LCD Screen and press the **Power** (⏻) button to turn on the camcorder.
 - Set the appropriate storage media. (SMX-C13/C14 only)
(If images were recorded on a memory card, insert the memory card.)
 2. Press the **Mode** (⊖) button to select the Play mode.
 - Set the Play Mode to **"Video."**
Press the **MENU** button and then use the **Control** button (▲ / ▼ / ◀ / ▶ / OK) to select **"Play Mode" → "Video."** (SMX-C13/C14 only)
 3. Press the **MENU** button → **Control** button (▲ / ▼ / ◀ / ▶ / OK) to select **"Edit" → "Divide."**
 4. Select a desired movie image using the **Control** button (▲ / ▼ / ◀ / ▶ / OK).
 - The selected movie image will be paused.
 5. Search the point of division by pressing the **Control** button (◀ / ▶ / OK).
 6. Press the **MENU** button to pause at the point of division.
 - A message appears asking for your confirmation.
 7. Select **"Yes."**
 - The selected movie image is divided into two movie images.
You can keep dividing images as long as they are 3 seconds in length.
 - If you want to delete an unwanted section of a movie image, divide the movie first, and then delete the image (section) you no longer need. After dividing the movie image, you can also combine other desired movie images. ↪page 80
 - The second image of the divided image will be displayed at the end of the thumbnail index.

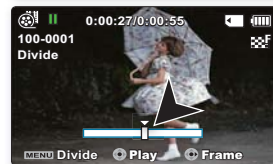
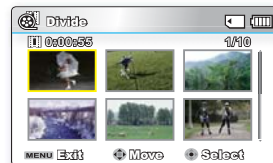
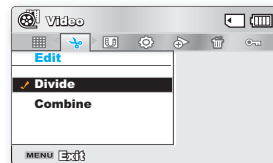

Example: You can divide a movie image into two in order to delete a section you no longer need.

1. Before dividing



0~60 seconds

2. After image is divided at 30 second point.



0~30 seconds

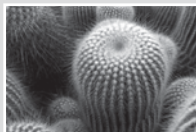

31~60 seconds

3. After deleting first image.

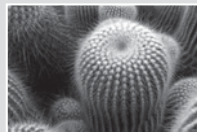

0~30 seconds

- The movie image is divided into two movie images.



• **The Divide function is not available in the following conditions:**

- If the total recorded time of the video is less than 6 seconds.
- If you trying to divide sections without leaving 3 seconds at the beginning and the end.
- If the video file is recorded in the Time Lapse REC mode.
- If the remaining section of the storage media space is less than 40MB.
- Videos recorded or edited by other devices.
- Videos transferred to this camcorder by using Samsung Intelli-studio.
- You can not delete a protected image. You must first release the protect function to delete it. ↪page 74
- The division point may drift before or after the designated point by approximately 0.5 seconds.

playback options

COMBINE

- This function works only in Play mode. ↪page 49
 - You can combine two different movie images.
1. Open the LCD Screen and press the **Power** (Ⓞ) button to turn on the camcorder.
 - Set the appropriate storage media. (SMX-C13/C14 only)
(If images were recorded on a memory card, insert the memory card.)
 2. Press the **Mode** (Ⓞ) button to select the Play mode.
 - Set the Play Mode to **"Video"**.
Press the **MENU** button and then use the **Control** button (▲/▼/◀/▶/OK) to select **"Play Mode" → "Video."** (SMX-C13/C14 only)
 3. Press the **MENU** button → Select **"Edit"** → Select **"Combine"**.
 4. Select a desired movie image using the **Control** button (▲/▼/◀/▶/OK).
 - The (V) indicator is displayed on the selected movie images.
 - Selecting the movie thumbnail image toggles between the movie thumbnail image being selected for combining (the (V) indicator appears on image) or not (the (V) indicator is removed from image).
 - You cannot select and combine two different resolution images.
 5. Press the **MENU** button.
 - A message appears asking for your confirmation.
 6. Select **"Yes."**
 - The thumbnail of the first movie image will appear in the combined movie image.



- **The combine function is not available in the following conditions:**
 - Videos in different resolution formats (TV super fine/TV fine/TV normal vs Web fine/Web normal) cannot be combined.
 - Videos in different aspect ratio cannot be combined. (4:3 vs 16:9 wide)
 - The video file recorded in the Time Lapse REC mode and normal record file cannot be combined.
 - If the total size of the two files to be combined exceeds 1.8GB
 - If the remaining section of the storage media space is less than 40MB.
 - If you combine videos having the same resolution but different qualities, the combined video will have the lower image quality for playback. (For example, if you combine a video clip of **"TV Super Fine"** with another video clip of **"TV Fine"**, which has the same resolution, then the combined video will be in **"TV Fine"** resolution and quality.)
 - Videos recorded or edited by other devices.
 - Videos transferred to this camcorder by using Samsung Intelli-studio.
- You cannot combine protected images. You must first release the protect function to paste it. ↪page 74
- The two movie images are combined in the selected order and restored as one movie image.
- The original movie images will not be preserved.
- A maximum of 2 movie images can be combined at a time.

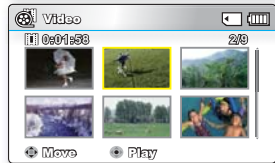
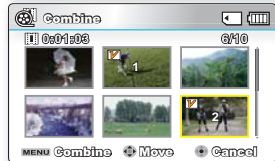
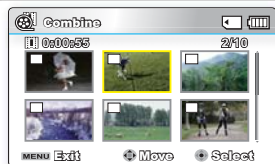

SHARE MARK

You can set the Share mark on the video image. Then you can directly upload the marked file to the YouTube site.

1. Open the LCD Screen and press the **Power** (⏻) button to turn on the camcorder.
 - Set the appropriate storage media. (SMX-C13/C14 only)
(If images were recorded on a memory card, insert the memory card.)
2. Press the **Mode** (Ⓜ) button to select the Play mode.
 - Set the Play Mode to **"Video."**
Press the **MENU** button and then use the **Control** button (▲ / ▼ / ◀ / ▶ / OK) to select **"Play Mode"** → **"Video."** (SMX-C13/C14 only)
 - The thumbnail index screen appears on the LCD screen accordingly.
3. Press the **MENU** button → **Control** button (◀ / ▶) to select **"Share Mark"** → **"Select File."**
4. Use the **Control** button (▲ / ▼ / ◀ / ▶) to select the desired movie images, and then press the **OK** button.
 - The (L) indicator is displayed on the selected movie images.
 - You can also check the Share mark on the video image by pressing **Share** (L) button.
5. Press the **MENU** button.
 - A message appears asking for your confirmation.
6. Select **"Yes."**

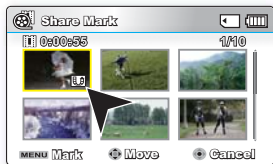
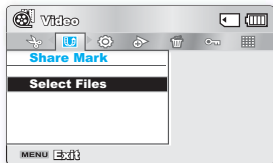

 By using the software Intelli-studio embedded in the camcorder, you can easily upload videos marked with Share marks. ➔page 101

playback options

SLIDE SHOW (SMX-C13/C14 ONLY)

You can playback all the photo images stored in the storage media automatically.

1. Open the LCD Screen and press the **Power** (⏻) button to turn on the camcorder.
 - Set the appropriate storage media.
(If images were recorded on a memory card, insert the memory card.)
2. Press the **Mode** (⊖) button to select the Play mode.
 - Set the Play Mode to **"Photo"**.
Press the **MENU** button and then use the **Control** button (▲ / ▼ / ◀ / ▶ / OK) to select **"Play Mode"** → **"Photo."**
 - The thumbnail index screen appears on the LCD screen accordingly.
3. Press the **MENU** button → **Control** button (◀ / ▶) to select **"Slide Show"** → **"Start."**
4. Press the **OK** button.
 - The (📺) indicator is displayed. The Slide Show will start from the current image.
 - All photo images will be played back consecutively for 2~3 seconds each.
 - To end the slide show, press the **OK** button again.



This function works only in Photo Play mode.
Before selecting a menu item, set the mode to Photo Play first.

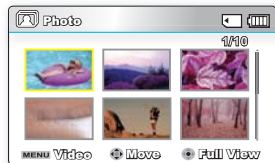

FILE INFO

You can see the image information for all images.

1. Open the LCD Screen and press the **Power** (⏻) button to turn on the camcorder.
 - Set the appropriate storage media. (SMX-C13/C14 only)
(If images were recorded on a memory card, insert the memory card.)
2. Press the **Mode** (⊖) button to select the Play mode.
 - Set the Play Mode to **"Video"** or **"Photo."**
Press the **MENU** button and then use the **Control** button (▲ / ▼ / ◀ / ▶ / OK) to select **"Play Mode" → "Video"** or **"Photo."** (SMX-C13/C14 only)
 - The thumbnail index screen appears on the LCD screen accordingly.
3. Select the desired movie (or photo) images using the **Control** button.
4. Press the **OK** button.
 - The selected movie (or photo) image is played according to play option setting.
5. Press the **MENU** button.
6. Press the **Control** button (◀ / ▶) to select **"File Info."**
7. Press the **OK** button.
 - The information of the selected file is displayed as shown below.
 - Date
 - Duration
 - Size
 - Resolution
- Press the **MENU** button again after confirming.

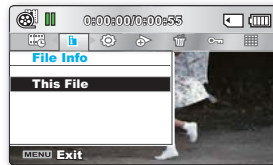
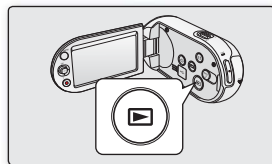

This function is available only in the full image display mode.

settings options

CHANGING THE MENU SETTINGS IN "SETTINGS"

You can change the menu settings to customise your camcorder.

Access the desired menu screen by following the steps below and change the various settings.

1. Open the LCD Screen and press the **Power** (⏻) button to turn on the camcorder.
2. Press **MENU** button.
 - The menu screen appears.
3. Press the **Control** button (◀ / ▶) to select "**Settings**."
 - The menus in "**Settings**" mode will appear.
4. Select the desired submenu and menu item with the **Control** buttons (▲ / ▼ / ◀ / ▶) and the **OK** button.
 - To return to the normal screen, press the **MENU** button.
 - Depending on the mode selected not all items will be selectable to be changed. (If there is no storage media inserted, it cannot be selected and will be dimmed on the menu: "**Storage (SMX-C13/C14 only)**", "**Storage Info**", "**Format**", "**File No.**" etc.)

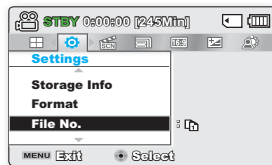
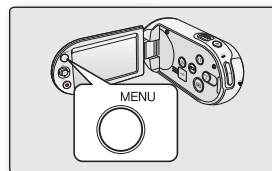

Button Tips

- a. **MENU** button : Use it to enter or exit the menu.
- b. **Control** button (▲ / ▼ / ◀ / ▶) : Use it to move up/down/left/right
- c. **OK** button : Use it to select or confirm the menu.



- The pop-up selection menu will appear depending on the selected menu item. In this case, select the desired item with the **Control** buttons (◀ / ▶) and the **OK** button.
- The illustration to the shows the Movie record mode. Before selecting a menu item, set the appropriate operation mode first. ➡page 24

MENU ITEMS

• You can setup the date/time, OSD language and display settings of the camcorder.

● : Possible

Settings menu items (⚙)

× : Not possible

Items	Record (📷) mode	Play mode (Thumbnail index screen)		Default values	Page
		Video (📹)	Photo * (📷)		
Storage *	●		●	Memory	86
Storage Info	●		●	-	86
Format	●		●	-	87
File No.	●		●	Series	87
Time Zone	●		●	Home	88
Date/Time Set	●		●	-	90
Date Type	●		●	-	90
Time Type	●		●	12Hr	90
Date/Time Display	●		●	Off	91
LCD Brightness	●		×	0	91
LCD Color	●		×	-	91
LCD Enhancer	●		●	Off	92
Auto LCD Off	●		●	On	92
Menu Design	●		●	Misty White	92
Transparency	●		×	0%	92
Beep Sound	●		●	On	93
Shutter Sound *	●		●	On	93
Auto Power Off	●		×	5 Min	93
PC Software	●		●	On	94
TV Display	●		×	On	94
Default Set	●		●	-	94
Version	●		●	-	95
Language	●		●	English	95
Demo	●		×	On	95





- These Items and Default values may be changed without notice.
- There are some functions you cannot activate simultaneously in the menu. You cannot select the grey menu items.
- Items marked with * are available only with SMX-C13/C14 models.

settings options

USING THE SETTINGS MENU ITEMS

Storage (SMX-C13/C14 only)

You can record movie (or photo) images on the built-in memory or a memory card, so you should select the desired storage media before starting recording or playback.

settings	contents	on-screen display
"Memory"	Select the built-in memory for storage medium. You can record or play back images on the built-in storage media.	
"Card"	Select a memory card as storage medium. You can record or play back images on a memory card.	



If there is no storage media inserted, it cannot be selected and will be dimmed on the menu.

Storage Info

It shows you the storage information. You can view the storage media, used memory space and available memory space.

settings	contents	on-screen display
"Memory"	It shows you the memory information of the built-in storage media.	None
"Card"	It shows you the memory information of the inserted memory card.	None



- If there is no storage media inserted, it cannot be selected and will be dimmed on the menu.
- In the Storage Info display, you can check the used and available memory as well as the remaining recording time for each recording resolution. For the desired information, scroll the screen using the **Control** (▲ / ▼) button.

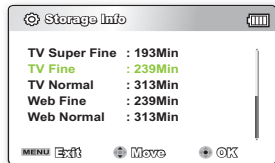
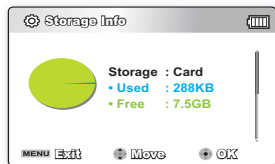

Format

The format function completely deletes all files and options on the storage media, including protected files.

You can format (initialise) recording data in the storage media. You have to format the pre-used storage media or newly purchased memory cards with this camcorder before using them. This enables stable speeds and operation when accessing the recording medium.

Be aware that all files and data including protected files will be erased.

settings	contents	on-screen display
"Memory"	Formats the built-in storage media.	None
"Card"	Formats the memory card.	None



WARNING

Donot format the recording medium with the PC or a different device.

Make sure to format the recording medium on the camcorder.



- Do not remove the recording medium or perform any other operation (such as turning off the power) during formatting. Also, be sure to use the provided AC power adaptor, as the recording medium may be corrupted if the battery becomes exhausted during formatting. If the recording medium becomes corrupted, format it again.
- A memory card with the protection tab set to lock will not be formatted. ➔page 41
- If there is no storage media inserted, it cannot be selected and will be dimmed on the menu.

File No.

File numbers are assigned to recorded files in the order they were recorded.

settings	contents	on-screen display
"Series"	Assigns file numbers in sequence even if the memory card is replaced with another one or after formatting, or after deleting all files. The file number is reset when a new folder is created.	None
"Reset"	Resets the file number to 0001 even after formatting, deleting all files or inserting a new memory card.	None



When you set "**File No.**" to "**Series**", each file is assigned with a different number so as to avoid duplicating file names. This is convenient when you want to manage your files on a PC.

settings options

Time Zone

You can easily set the clock to the local time when using your camcorder while travelling.

settings	contents	on-screen display
"Home"	The clock will be used according to your setting on the "Date/Time Set" menu. Select it when using this camcorder for the first time or when returning the clock to your hometown date/time setting.	None
"Visit"	When you visit a different time zone, it allows you to use the local time without changing your hometown time setting. The clock will be adjusted in accordance with the time difference between the two locations.	

Setting the clock to the local time ("Visit")

You can easily set the clock to the local time zone when travelling.

1. Press the **Control** button (▲ / ▼) to select the **"Time Zone"** in Settings mode, and then press the **OK** button.
 - The Time Zone screen will be displayed.
2. Select **"Visit"** with the **Control** button (▲ / ▼ / OK), and then select your local area using the **Control** button (◀ / ▶).
 - You can check the time difference between **"Home"** and **"Visit."**
3. Press the **OK** button to confirm.
 - The clock is set to the time zone of the place you are visiting.
 - When **"Date/Time Display" : "On"** is set, the icon () will be displayed next to the date and time display. ➔page 91

 You can set the date and time in **"Date/Time Set"** from the **"Settings"** menu.
➔page 35

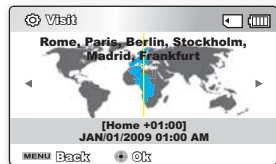
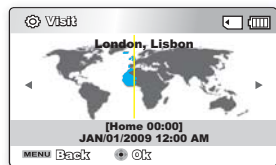

Cities used to set the time zone

Cities	Time zone	Cities	Time zone
London, Lisbon	+00:00	Adelaide	+09:30
Rome, Paris, Berlin, Stockholm, Madrid, Frankfurt	+01:00	Guam, Sydney, Brisbane	+10:00
Athens, Helsinki, Cairo, Ankara	+02:00	Solomon Islands	+11:00
Moskva, Riyadh	+03:00	Wellington, Fiji	+12:00
Teheran	+03:30	Samoa, Midway	-11:00
Abu Dhabi, Muscat	+04:00	Honolulu, Hawaii, Tahiti	-10:00
Kabul	+04:30	Alaska	-09:00
Tashkent, Karachi	+05:00	LA, San Francisco, Vancouver, Seattle	-08:00
Calcutta, New Delhi	+05:30	Denver, Phoenix, Salt Lake City	-07:00
Almaty, Kathmandu	+05:45	Chicago, Dallas, Houston, Mexico City	-06:00
Dacca	+06:00	New York, Miami, Washington D.C., Montreal, Atlanta	-05:00
Yangon	+06:30	Caracas, Santiago	-04:00
Bangkok	+07:00	Buenos Aires, Brasilia, Sao Paulo	-03:00
Hong Kong, Beijing, Taipei, Singapore, Manila	+08:00	Fernando de Noronha	-02:00
Seoul, Tokyo, Pyongyang	+09:00	Azores, Cape Verde	-01:00



The times are based on Greenwich Mean Time (GMT).

settings options

Date/Time Set

Set the current date and time so they can be recorded correctly. ➔page 35

Date Type

You can select the desired date type.

Settings	Contents	On-screen display
2009/01/01	Displays the date in the order of year, month (two-digit) and day.	2009/01/01
JAN/01/2009	Displays the date in the order of month, day and year.	JAN/01/2009
01/JAN/2009	Displays the date in the order of day, month and year.	01/JAN/2009
01/01/2009	Displays the date in the order of day, month (two-digit) and year.	01/01/2009



This function depends on the “**Date/Time Display**” setting.

Time Type

You can select the time format to display.

Settings	Contents	On-screen display
12 Hr	The time is displayed in 12 hour units.	12:00 AM
24 Hr	The time is displayed in 24 hour units.	00:00



This function depends on the “**Date/Time Display**” setting.

Date/Time Display

You can set the date and time to display on the LCD screen.

- Before you use the **"Date/Time Display"** function, you must set the date and time. ↪ page 35

Settings	Contents	On-screen display
Off	Current date and time information is not displayed.	None
Date	Displays the current date.	JAN/01/2009
Time	Displays the current time.	12:00 AM
Date & Time	Displays the current date and time.	JAN/01/2009 12:00 AM



- The date/time will read **"JAN/01/2009 12:00 AM"** in the following conditions:
 - The built-in rechargeable battery becomes weak or dead.
- This function depends on the **"Date Type"** and **"Time Type"** setting.

LCD Brightness

- You can adjust the brightness of the LCD screen to compensate for ambient lighting conditions.
- Pressing the **Control** button (▶) will brighten the screen whereas pressing the **Control** button (◀) will darken the screen.



- A brighter LCD screen setting consumes more battery power.
- If you adjust the LCD brightness when the ambient lighting is too bright, it is hard to see the monitor indoors.
- LCD Brightness does not affect the brightness of images to be stored.
- You can adjust the LCD Brightness from -15 to 15.

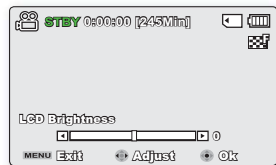

LCD Color

- You can change the color impression of the screen with a variety of color options by adjusting the red and blue color range.
- When you set red and blue color range, the higher the figures, the brighter the LCD screen will be.
- You can adjust the LCD color (red/blue) from -15 to 15, using the **Control** button (▲ / ▼ / ◀ / ▶ / OK).



- You can manipulate the color displayed on the LCD screen by adjusting the color ratio of red and blue.
- Adjusting the color display of LCD screen does not affect the image to be recorded.
- Higher the value will produce brighter LCD screen when adjusting color range of red and blue.

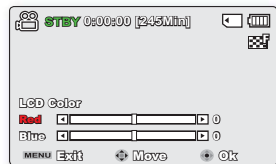

settings options

LCD Enhancer

Contrast is enhanced for a clear and bright image. This effect is also implemented outdoors in bright daylight.

settings	contents	on-screen display
"Off"	Disables the function	None
"On"	LCD Enhancer is executed.	

-  LCD Enhancer function does not affect the quality of the image being recorded.
- When the LCD Enhancer works at low illumination, some stripes may occur on the LCD screen. This is not a malfunction.
- Using the LCD Enhancer function may cause colour look different on the display.

Auto LCD Off

To reduce power consumption, the brightness of the LCD screen is automatically dimmed if the camcorder is idle for more than 2 minutes.

settings	contents	on-screen display
"Off"	Disables the function	None
"On"	When the camcorder is idle for more than 2 minutes in Video or Photo STBY mode, or for more than 5 minutes when recording a video, the power saving mode starts by dimming the LCD screen.	None

-  When this **"Auto LCD Off"** function is enabled, you can press any button on the camcorder to return LCD brightness to normal.

Menu Design

You can select the desired menu design.

- "Misty White" → "Premium Black "**

Transparency

You can select the desired transparency to display the menu.

- "0%" → "20%" → "40%" → "60%"**

-  The setting value is applied to the menu screen of Record mode only.

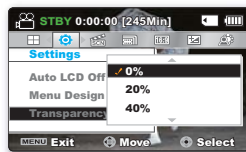

<Transparency 0%>

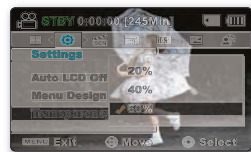

<Transparency 60%>

Beep Sound

You can set the beep sound to on/off. If there is a beep sound when operating the menu settings, the setting is turned on.

settings	contents	on-screen display
"Off"	Disables the function	None
"On"	When on, a beep will sound every time a button is pressed.	None



The Beep sound function is canceled in the following cases:

- During recording, playing
- When the camcorder has a cable connection. (AV cable)

Shutter Sound (SMX-C13/C14 only)

You can turn the shutter sound on or off.

settings	contents	on-screen display
"Off"	Disables the function	None
"On"	When on, the shutter will sound with each press of the PHOTO (Ⓢ) button.	None

Auto Power Off

To save battery power, you can set the "**Auto Power Off**" function which turns off the camcorder if there is no operation for a certain period of time.

settings	contents	on-screen display
"Off"	The camcorder does not turn off automatically.	None
"5 Min"	For power saving purpose, the camcorder will automatically turn power off if there is no operation for 5 minutes in STBY mode or in thumbnail index view.	None



- **Auto Power Off will be disabled in the following cases:**
 - If the DC power cable (AC power adaptor, USB cable) is connected
 - While the "**Demo**" menu is running
 - During recording, playing (Pause excluded), or a slideshow
- Press the **Power** (Ⓢ) button to restart the camcorder.

settings options

PC Software

If you set PC Software to on, you can simply use the PC software by connecting the USB cable between the camcorder and your PC. You can download the stored video and photo images stored on the camcorder to your PC's hard disk. Editing video/photo files is also available using the PC software.

settings	contents	on-screen display
"Off"	Disables the function	None
"On"	You can simply use the PC software by connecting the USB cable between the camcorder and your PC.	None



- The PC Software is compatible with the Windows OS only.
- The photo function is available only with SMX-C13/C14 models

TV Display

You can select the output path of the OSD (On Screen Display).

settings	contents	on-screen display
"Off"	The OSD appears in the LCD screen only.	None
"On"	The OSD appears in the LCD screen and TV. (Connecting to a TV ➡ page 106)	None

Default Set

You can initialise your camcorder settings to the factory defaults (initial settings at the factory). Initialising the camcorder settings to factory defaults does not affect recorded images.



- After resetting the camcorder, set "**Time Zone**" and "**Date/Time Set.**" ➡ page 35

Version

The version information may be changed without notice for improvement.

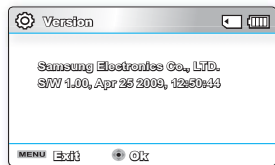

Language

You can select a desired language to display the menu and messages. ➔page 37

Demo

Demonstration automatically shows you the major features that are included with your camcorder so that you may use them more easily.

settings	contents	on-screen display
"Off"	Disables the function	None
"On"	Activates demonstration mode and shows various features on the LCD screen.	None

Using the Demo function

- The Demo mode is canceled in the following cases:
 - If any button is operated (**Recording start/stop**, **PHOTO** (⊕), **EASY Q**, etc.)
However, the camcorder will enter the Demo mode automatically after 5 minutes in STBY mode if it is idle for 5 minutes without operation. If you don't want the Demo function to start, set "**Demo**" to "**Off**".



The Demo function does not operate in the following cases:

- If "**Auto Power Off**" is set to "**5 Min**"(uses the battery as main power), the Auto Power Off function will turn the camcorder off before Demo can run.



using with a Windows computer

CHECKING YOUR COMPUTER TYPE

This chapter explains how to connect the camcorder to a computer using the USB cable.

Check your computer type before using!!!

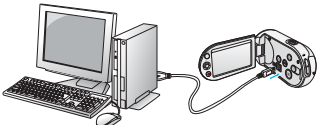
To view your recordings on a computer, you need to check your computer type first. Then, take the steps below according to your computer type.

Using with Windows		Using with Macintosh
<p>Connect your camcorder to the computer using the USB cable.</p> <ul style="list-style-type: none">The built-in editing software Intelli-studio, runs on the PC automatically once the camcorder is connected to a Windows computer. (When you specify “PC Software: On”). → page 94		
<p>Play back or edit your recordings on the computer using the built-in, Intelli-studio application. → page 98</p>		<ul style="list-style-type: none">The built-in software on your camcorder, 'Intelli-studio', is not Macintosh compliant.
<p>You can also upload your recordings to YouTube or other web sites using Intellistudio. → page 101</p>		

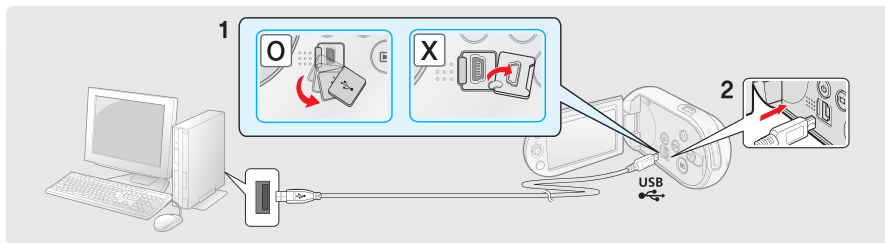

WHAT YOU CAN DO WITH A WINDOWS COMPUTER

You can enjoy the following operations by connecting your camcorder to your Windows computer by using a USB cable.

Main Functions

- By using the built-in editing software, 'Intelli-studio' on your camcorder, you can enjoy the following operations:
 - Playing back recorded videos or photos. ↪page 100
 - Editing recorded videos or photos. ↪page 100
 - Uploading the recorded videos and photos to YouTube or Flickr, etc. ↪page 101
- You can transfer or copy the files (videos and photos) saved on the storage media to your computer. (Mass storage function) ↪page 105



The photo function is available only with SMX-C13/C14 models.

System Requirements

The following requirements must be met for using the built-in editing software (Intelli-studio):

Items	System Requirements
OS (Operating System)	Microsoft Windows XP, Vista
CPU	Intel® Pentium®4 3.0 GHz or higher AMD Athlon FX™ 3.0 GHz or higher
RAM	512 MB (1 GB or higher recommended)
Video Card	nVIDIA Geforce 7600GT or higher Ati X1600 series or higher
Display	1024 x 768, 16-bit color or higher (1280 x 1024, 32-bit color recommended)
USB	USB 2.0 support
Direct X	DirectX 9.0 or higher



- System requirements mentioned above are recommendations. Even on a system that meets the requirements, operations may not be ensured depending on the system.
- On a slower computer than recommended, video playback may skip frames or operate unexpectedly.
- When the version of DirectX on your computer is lower than 9.0, install the program in version 9.0 or higher.

using with a Windows computer

USING THE INTELLI-STUDIO PROGRAM

Using the built-in Intelli-studio program in your camcorder, you can transfer video/photo files onto your PC and edit them on your computer. The Intelli-studio offers the most convenient way for you to manage video/photo files by using the simple USB cable connection between the camcorder and your PC.

Starting the Intelli-studio program

Step 1. Connecting the USB cable

1. Set the menu setting to **“PC Software: On”**. → page 94
 - You will find the default menu settings are set as shown at right.
2. Connect the camcorder and the PC with the USB cable.
 - A new file saving screen appears with the Intelli-studio main window.
 - According to your computer type, the corresponding removable disk window appears.
3. Click **“Yes”**, the uploading procedure will start. Click **“Yes”** to confirm.
 - If you do not want to save a new file, select **“No.”**

Disconnecting the USB cable

After completing the data transfer, make sure to disconnect the cable in the following way:

1. Click on the “Safely Remove Hardware icon” icon on the taskbar.
2. Select “USB Mass Storage Device”, and then click “Stop”.
3. If the “Stop a Hardware device” window appears, click “OK.”
4. Disconnect the USB cable from the camcorder and PC.



- Use the provided USB cable. (Supplied by Samsung)
- Don't apply excessive force when inserting or extracting the USB cable into/from a USB jack.
- Insert the USB after checking the correct direction of its insertion.
- We recommend using the AC power adaptor as power supply instead of the battery pack.
- When the USB cable is connected, turning the camcorder on or off may cause the PC to malfunction.
- If you disconnect the USB cable from the PC or the camcorder while transferring data, the data transfer will stop and the data may be damaged.
- If you connect the USB cable to a PC via a USB HUB or simultaneously connect the USB cable along with other USB devices, the camcorder may not work properly. If this occurs, remove all USB devices from the PC and reconnect the camcorder.
- According to your computer type, the Intelli-studio program may not run automatically. In this case, open the desired CD-ROM drive that has the Intelli-studio program in My Computer and run iStudio.exe.
- When a USB cable is connected, if you have EmoDio (Samsung's MP3 player software) installed on your computer, the EmoDio software may load first.

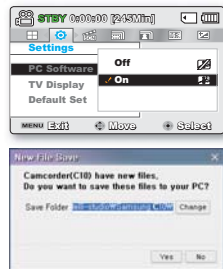

Step 2. About the Intelli-studio main window

- When the Intelli-studio starts up, thumbnails of videos and photos are displayed in the main window.

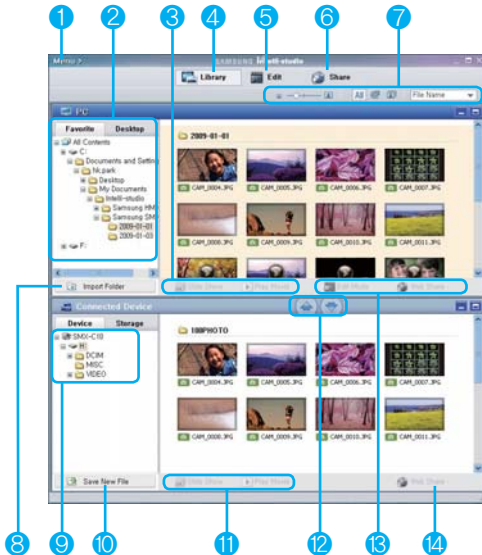

- Menu items
- Selects the Desktop or Favorite on the PC.
- Slide show of the photo files from the PC.
Playback of the video files from the PC.
- Switches to Library of the PC and connected camcorder.
- Switches to Edit mode.
- Switches to Share mode.
- Changes the size of thumbnails.
Displays all files (videos and photos)/Displays video files only.
Displays photo files only.
Sorts the files.
- Imports folders from PC.
- Selects the connected camcorder or storage.
- Saves new files to PC.
- Slide show of the photo files from the connected camcorder.
Playback of the video files from the connected camcorder.
- Saves the selected file to PC.
Saves the selected file to connected camcorder.
- Moves the file selected in the PC to the Edit mode.
Moves the file(s) selected in the PC to the Share mode.
- Moves the file(s) selected in the connected camcorder to the Share mode.

using with a Windows computer

Step 3. Playing back videos (or photos)

- You can play back the recordings conveniently using the Intelli-studio application.
1. Run the Intelli-studio program. → page 98
 2. Click the desired folder to display your recordings.
 - Video (or photo) thumbnails appear on the screen, according to the selected source.
 3. Select the video (or photo) that you want to play, and then double-click to play back.
 - Playback starts and the playback controls appear.



Step 4. Editing videos (or photos)

With Intelli-studio, you can edit videos or photos in various ways. (Movie Effect, Fine-Tuning, Transition Effect, Insert Text etc.)

- Select the video (or photo) you want to edit, and then click on the **“EDIT”** icon.

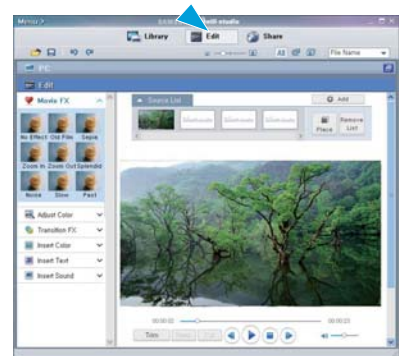

Step 5. Sharing the video/photo images online

Share your contents with the world by uploading photos and videos directly to a web site with one click.

1. To do this, select **“Share”** in the main Video window.
2. Click **“Add”** and move the video or photo (drag and drop) to the sharing window for upload.
 - The selected file appears in the sharing window.
3. Click on the website you would like to upload files to.
 - You can choose “YouTube,” “Flickr,” or the specified website you want to set for your uploading management.
4. Click **“Upload to Share Site”** to start uploading.
 - A pop-up window appears asking for your ID and the password.
5. Enter your ID and password to access.
 - Access to the web site contents can be limited depending on your web access environment.



- For more information about the Intelli-studio use, see the Help Guide by clicking the **“Menu”** → **“Help”**.
- You can simply upload share marked videos onto YouTube by pressing the **Share** () button.

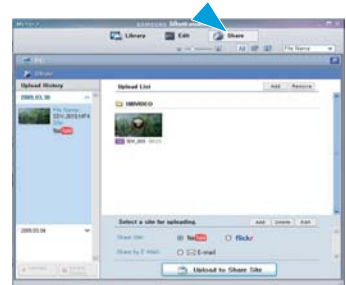

using with a Windows computer

Direct uploading your videos onto YouTube

One-Touch Share (L) button lets you directly upload and share your videos onto YouTube. Just press the **Share** (L) button while your camcorder is connected to a Windows computer using the supplied USB cable.

Step 1

Set the Share mark on the desired videos which you want to upload directly onto the YouTube site. Press the Control (▲/▼/◀/▶) button and the Share (L) button to select a desired video in the video thumbnail index view.

- The Share mark (L) is displayed on the selected videos.
- You can also set the Share mark on selected videos using the menu. ↪ page 81

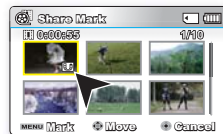

Step 2

Connect the camcorder and a PC with the supplied USB cable. ↪ page 98

- The Intelli-studio runs automatically once the camcorder is connected to a Windows computer (when you specify “PC Software: On”).



Step 3

Press the Share (L) button while your camcorder is connected to a computer using the supplied USB cable.

- Selected videos with the Share marks are displayed on the Sharing screen.
- Click the “Yes” on the PC screen to begin uploading your videos to YouTube.
- If you want to upload directly without showing a pop-up sharing window, check “Intelli-studio does not pop a list of share marked files in the connected device.”

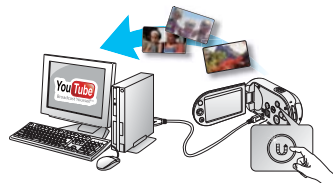

- Your YouTube account must be activated to use the upload feature.
- When uploading to the YouTube, the selected movie will be converted into a format playable by YouTube before uploading. Time spent for uploading may vary depending on the user’s conditions including computer and network performance.
- There is no guarantee of uploading operation in all environments, and YouTube server-side changes in the future may disable this function.
- For more information on YouTube, visit the YouTube website: <http://www.youtube.com/>
- This product’s YouTube uploading functionality is provided under the license from YouTube LLC. The presence of YouTube uploading functionality of this product is not an endorsement or recommendation of the product by YouTube LLC.
- If you do not have a YouTube account, you must register first before proceeding with the authorization.
- According to YouTube’s policy, direct movie uploading may not be available in your nation / region.

Other functions with the Intelli-Studio

Importing and viewing the video/photo images from your PC

1. Launch the Intelli-studio program by double-clicking the program icon on the desktop screen or connect the camcorder to your PC.
2. Click **"Import Folder"** to import the video or photo files from your PC.
3. The selected video or photo files are imported from your PC, and you can see the files' location on the Intelli-studio browser.
4. You can double-click on the file you would like to start playback.

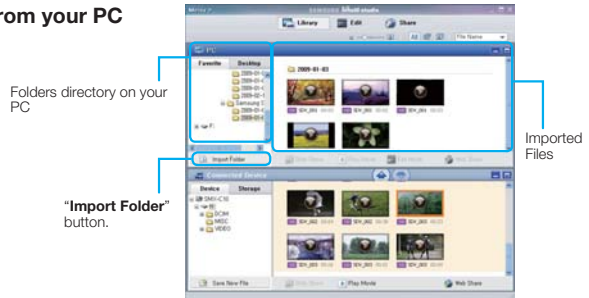

The following is the file format supportable in Intelli-studio:

- Video formats: MP4 (Video: H.264, Audio: AAC), WMV (WMV 7/8/9)
- Photo formats: JPG, GIF, BMP, PNG, TIFF

Exporting the videos/photos to your camcorder.

1. Select the desired files to export.
2. Click on the  icon to export the files to your camcorder.
3. The following pop-up window appears.
4. Click on the **"OK"** to export files. The files are saved to your camcorder.

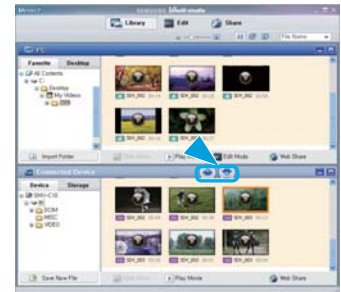

While transferring any file, do not disconnect the USB cable. It may cause damage to the camcorder or computer.



- When storing a video through Intelli-studio, it is automatically stored into an MP4 file that can be played back. However, the only video file format supportable in Intelli-studio can be converted and stored in the camcorder.
- According to the resolution and type of the video, the storing time may differ.
- Photos cannot be stored on the camcorder through Intelli-studio.
- Storing a video into the camcorder by using the Intelli-studio may not spontaneous in playback or may produce deteriorated quality, depending on original's format.

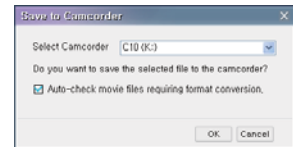

using with a Windows computer

Installing Intelli-studio application on a Windows computer

- When the Intelli-studio application is installed on a Windows computer, it will run faster after connecting the camcorder to your computer. Moreover, the application can be updated automatically and run directly on the Windows computer.
- The Intelli-studio application can be installed on a Windows computer as follows:
Click on **“Menu”** → **“Install Intelli-studio on PC.”** in the Intelli-studio screen.

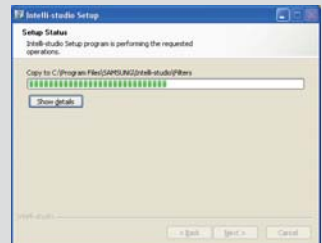
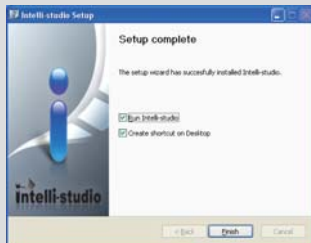
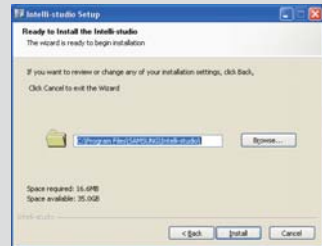

TRANSFERRING VIDEOS/PHOTOS FROM THE CAMCORDER TO YOUR COMPUTER

You can transfer or copy recorded data to a Windows computer by connecting the USB cable to the camcorder.

Step 1. Viewing the contents of storage media (built-in memory or memory card)

1. Check the “PC Software: Off” setting. ↪ page 94
2. Check the storage media.
(If you have video or photos recorded on a memory card, insert the memory card.) (SMX-C13/C14 only)
3. Connect the camcorder to the PC with the USB cable. ↪ page 98
 - The “Removable Disk” or “Samsung” window appears on the PC’s screen after a moment.
 - The removable disk appears when connecting a USB.
 - Select “Open folders to view files using Windows Explorer.” and click “OK.”
4. The folders in the storage media appear.
 - Different file types are stored in different folders.

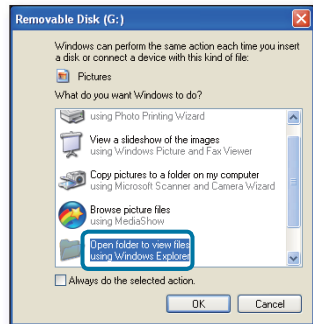

- If the “Removable Disk” window does not appear, confirm the connection (↪ page 98) or repeat steps 1 and 3 again.
- When the removable disk does not appear automatically, open the removable disk folder of My Computer.
- If the connected camcorder’s disk drive does not open or the context menu that appears when right-clicking your mouse (open or browse) appears broken, your computer may be infected by an Autorun virus. Be sure to update your antivirus software to the latest version.

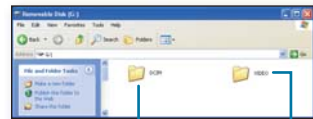

Photos

Videos

using with a Windows computer

Structure of folders and files on the storage media

- The folder and file structure for built-in memory or memory card is as follows.
- Don't arbitrarily change or remove the folder or file name. It may not be playable.

Movie Images (H.264) ①

- The SD-quality movie images are named as "SDV_####.MP4" and Web movie images are named as "WEB_####.MP4".
- The SD quality movie images will be named as SDE_####.MP4 when you edit movie images using the PC software.
- The file number automatically increases when a new movie image file is created. Up to 9,999 files can be created in one folder.
- A new folder is created when more than 9,999 files are created.

Photo Images ②

- As with movie image files, the file number automatically increases when a new image file is created.
- The maximum file number allowed is the same as in movie image files. A new folder stores files starting with CAM_0001.JPG.
- The folder name increases in the order of 100PHOTO → 101PHOTO etc.
- Up to 9,999 files can be created in one folder. A new folder is created when more than 9,999 files are created.

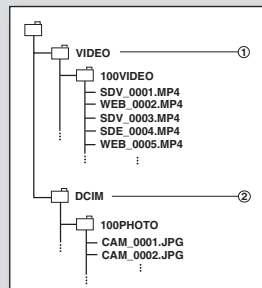

Image format

Movie Images

- Movie images are compressed in H.264 format. The file extension is **".MP4."**
- Refer to page 58 for video resolution.

Photo Images

- Photo images are compressed in JPEG (Joint Photographic Experts Group) format. The file extension is **".JPG."**
- Refer to page 59 for photo resolution.



- When the 9,999th file is created in the 999th folder (i.e. SDV_9999.MP4 is created in the 999 VIDEO folder), no more folders can be created. Backup your files to a PC and format the storage media, and then reset the file numbering from the menu.
- We don't recommend you modify the name of a file/folder stored in the storage media using a PC. If you modify it, this camcorder may not recognise the modified files.
- You can use your camcorder as a storage device.
- The photo function is available only with SMX-C13/C14 models.

connecting to other devices

You can view the recorded movie and photo images on a large screen by connecting the camcorder to a TV.

CONNECTING TO A TV

- To playback your recordings, the television must be NTSC compatible. ➔page 113
- We recommend that you use the AC power adaptor as power source for the camcorder.

Use the provided Audio/Video cable to connect the camcorder to a TV as follows:

1. Connect the end of the Audio/Video cable with the single plug to the Audio/Video cable jack of the camcorder.
2. Connect the other end with video (yellow) and left (white)/ right (red) audio cables to the TV.

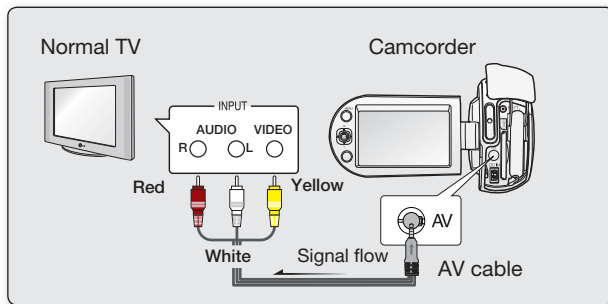

- For more information about the connection, refer to your TV's user manual.
- Before connecting, make sure that the volume on the TV is turned down: forgetting this may cause feedback from the TV speakers.
- Carefully connect the input and output cables to the corresponding connections on the device the camcorder is being used with.

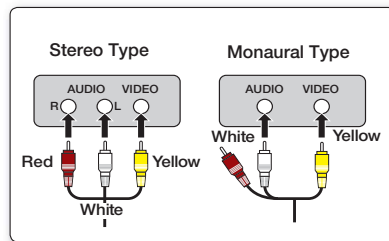

connecting to other devices

VIEWING ON A TV SCREEN

1. Turn on the TV and set the input selector to the Input connection the camcorder is connected to.
 - This is often referred to as "line." Refer to the TV instruction manual for how to switch the TV input.
2. Turn the camcorder on.
 - Press the **Mode** (Ⓜ) button to select the Play mode. ➔ page 49
 - The camcorder image will appear on the TV screen.
 - You can also monitor the image on the LCD screen of the camcorder.
3. Perform playback.
 - You can perform playback, recording or setting the menu while viewing on a TV screen.

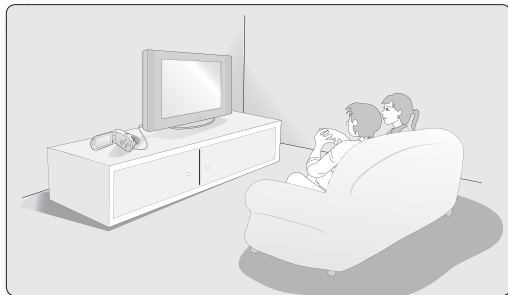

- When **"TV Display"** is set to **"Off"**, OSD (On-Screen-Display) does not appear on the TV screen. ➔ page 94
- Feedback may occur when the camcorder is too close to the other devices or the volume is high. Keep the camcorder a reasonable distance away from the other connected devices.
- When the Audio/Video cable is connected to the camcorder, the built-in speaker will automatically turn off and you cannot adjust the volume bar.

Image display depending on LCD and TV screen ratio

	Record	Photo	LCD	TV	
				16:9	4:3
16:9					
4:3					

- Refer to page 59 for the **"16:9 Wide"** setting.
- The photo function is available only with SMX-C13/C14 models.



RECORDING (DUBBING) IMAGES ON A VCR OR DVD/HDD RECORDER

You can record (dub) images played back on this camcorder onto other video devices, such as VCRs or DVD/HDD recorders. Use the Audio/Video cable (provided) to connect the camcorder to another video device as shown in the following figure:

1. Press the **Mode** (Ⓜ) button to select the Play mode. ➔page 49
2. Choose the recorded (dubbed) images on the thumbnail view and then press the **OK** button.
3. Press the record button on the connected device.
 - The camcorder will start playback and the recording device will record (dub) it.

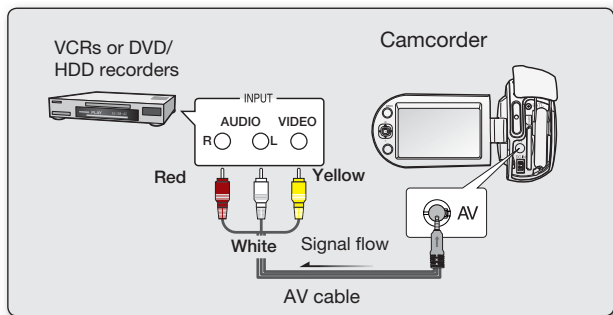

- Be sure to use the AC adaptor to power the camcorder from a household AC outlet to prevent battery power from shutting off during recording on another video device.
- To prevent recording OSD (information) to be displayed along with the AV signal, set the **"TV Display"** to **"Off"** in Menu Settings. ➔page 94

maintenance & additional information

MAINTENANCE

Your camcorder is a product of superior design and craftsmanship and should be treated with care. The suggestions below will help you fulfil any warranty obligations and allow you to enjoy this product for many years.

- ✪ For safekeeping of the camcorder, be sure to turn it off.
 - Remove the battery pack and AC power adaptor. ➔page 16
 - Remove the memory card. ➔page 39

Cautions on Storing

- **Do not leave the camcorder in a place where the temperature is very high for a long period of time:**
The temperature inside a closed vehicle or trunk can become very high in a hot season. If you leave the camcorder in such a place, it could malfunction or the case could be damaged. Do not expose the camcorder to direct sunlight or place it near a heater.
- **Do not store the camcorder in a place where the humidity or dust level is high:**
Dust entering the camcorder could cause a malfunction. If humidity is high, the lens could become moldy, and the camcorder could become inoperative. It is recommended that you put the camcorder in a box together with a desiccant packet to help protect it from humidity when storing it in a closet, etc.
- **Do not store the camcorder in a place subject to strong magnetism or intense vibrations:**
This could cause malfunctions.
- **Detach the battery pack from the camcorder and store it in a cool place:**
Leaving the battery pack attached or storing it at high temperature could shorten its life.

Cleaning the camcorder

- ✪ **Before cleaning, turn off the camcorder and remove the battery pack and AC power adaptor.**
- **To clean the exterior**
 - Wipe gently with a soft dry cloth. Do not apply excessive force when cleaning, gently rub the surface.
 - Do not use benzene or thinner to clean the camcorder. The coating of exterior could peel off or the case could deteriorate.
- **To clean the LCD monitor**
Wipe gently with a soft dry cloth. Be careful not to damage the monitor.

- **To clean the lens**

Use an optional air blower to blow out dirt and other small objects. Do not wipe the lens with cloth or your fingers. If necessary, wipe gently with lens cleaning paper.

- Mold may form if the lens is left dirty.
- If the lens looks dimmer, turn off the camcorder and leave it for about 1 hour.

ADDITIONAL INFORMATION

Storage media

- **Be sure to follow the guidelines below to prevent corruption or damage of your recorded data.**
 - Do not bend or drop the storage media, or subject it to strong pressure, jolts or vibrations.
 - Do not splash the storage media with water.
 - Do not use, replace, or store the storage media in locations that are exposed to strong static electricity or electrical noise.
 - Do not turn off the camcorder power or remove the battery or AC power adaptor during recording, playback, or when otherwise accessing the storage media.
 - Do not bring the storage media near objects that have a strong magnetic field or that emit strong electromagnetic waves.
 - Do not store the storage media in locations with high temperature or high humidity.
 - Do not touch the metal parts.
- **Copy the recorded files to your PC. Samsung shall not be responsible for any lost data. (It is recommended that you copy the data from your PC to other media for storage.)**
- **A malfunction may cause the storage media to fail to operate properly. Samsung will not provide any compensation for any lost contents.**
- **Refer to pages 38-44 for details.**

LCD screen

- **To prevent damage to the LCD screen**
 - Do not push it too hard or knock it on anything.
 - Do not place the camcorder with LCD screen facing down.
- **To prolong service life, avoid rubbing it with a coarse cloth.**
- **Be aware of the following phenomena for LCD screen use. They are not malfunctions.**
 - While using the camcorder, the surface around the LCD screen may heat up.
 - If you leave power on for a long time, the surface around the LCD screen becomes hot.

maintenance & additional information

Battery packs

The supplied battery pack is a lithium-ion battery. Before using the supplied battery pack or an optional battery pack, be sure to read the following cautions:

- **To avoid hazards**

- Do not burn.
- Do not short-circuit the terminals. When transporting, carry the battery in a plastic bag.
- Do not modify or disassemble.
- Do not expose the battery to temperatures exceeding 60°C (140°F), as this may cause the battery to overheat, explode or catch fire.

- **To prevent damage and prolong service life**

- Do not subject to unnecessary shock.
- Charge in an environment where temperatures are within the tolerances shown below. This is a chemical reaction - cooler temperatures impede chemical reaction, while warmer temperatures can prevent complete charging.
- Store in a cool, dry place. Extended exposure to high temperatures will increase natural discharge and shorten service life.
- Fully charge the battery pack at least every 6 months when storing the battery pack over a long period of time.
- Remove from your camcorder when not in use, as these components may use current even when switched off.



- It is recommended that only genuine **Samsung** batteries be used in this camcorder. Using generic non-**Samsung** batteries can cause damage to the internal charging circuitry.
- It is normal for the battery pack to be warm after charging, or after use.

Temperature range specifications

- Charging: 50°F to 95°F (10°C to 35°C)
 - Operation: 32°F to 104°F (0°C to 40°C)
 - Storage: -4°F to 140°F (-20°C to 60°C)
- The lower the temperature, the longer recharging takes.
 - **Refer to pages 16-22 for details.**

USING YOUR CAMCORDER ABROAD

- Each country or region has its own electric and color systems.
- Before using your camcorder abroad, check the following items.

Power sources

The provided AC adaptor enables you to use your camcorder in any country/region within the AC 100 V to 240 V, 50/60 Hz range. Use a commercially available AC plug adaptor, if necessary, depending on the design of the wall outlet.

On TV color systems

Your camcorder is an **NTSC**-system-based camcorder. If you want to view your recordings on a TV or to copy it to an external device, it must be an **NTSC**-system-based TV or an external device having the appropriate Audio/Video jacks. Otherwise, you may need to use a separate video format transcoder (NTSC-PAL format converter).



The format transcoder is not provided by SAMSUNG.

NTSC-compatible countries/regions

Bahamas, Canada, Central America, Japan, Korea, Mexico, Philippines, Taiwan, United States of America, etc.

PAL-compatible countries/regions

Australia, Austria, Belgium, Bulgaria, China, CIS, Czech Republic, Denmark, Egypt, Finland, France, Germany, Greece, Great Britain, Netherlands, Hong Kong, Hungary, India, Iran, Iraq, Kuwait, Libya, Malaysia, Mauritius, Norway, Romania, Saudi Arabia, Singapore, Slovak Republic, Spain, Sweden, Switzerland, Syria, Thailand, Tunisia, etc.



You can make recordings with your camcorder and view pictures on the LCD screen from anywhere in the world.

troubleshooting

TROUBLESHOOTING



- ❗ Before contacting a Samsung authorised service center, perform the following simple checks. They may save you the time and expense of an unnecessary call.





Warning indicators and messages

Power source

Message	Icon	Informs that...	Action
Low Battery	-	The battery pack is almost discharged.	<ul style="list-style-type: none">Change to a charged one or use the AC power adaptor. Charge the battery pack.

Storage media

Message	Icon	Informs that...	Action
Memory Full (SMX-C13/C14 only)		There is not enough space to record on the built-in memory.	<ul style="list-style-type: none">Delete unnecessary files on the built-in memory. Use a memory card.Back-up files to your PC or another storage media and delete files.
Insert Card		There is no memory card inserted in the card slot.	<ul style="list-style-type: none">Insert a memory card.
Card Full		There is not enough space to record on the memory card.	<ul style="list-style-type: none">Delete unnecessary files on the memory card. Use the built-in memory. (SMX-C13/C14 only)Back-up files to your PC or another storage media and delete files.Change to another memory card which has enough free space.

Message	Icon	Informs that...	Action
Card Error		The memory card has some problem and cannot be recognized.	<ul style="list-style-type: none"> Format the memory card or replace it with a new one.
Card Locked		The write protection tab on an SDHC card has been set to lock.	<ul style="list-style-type: none"> Release the write protection tab.
Not Supported Card		The memory card is not supported in this camcorder.	<ul style="list-style-type: none"> Change to a memory card that we recommended.
Please format		The memory card is not formatted.	<ul style="list-style-type: none"> Format the memory card using the menu.
Not formatted. Format the Card? (Format the memory?)	-	The format of the file is not supported by this camcorder.	<ul style="list-style-type: none"> The file format is not supported. Check the supported file. Format the memory card using menu item.
Low speed card. Please record a lower resolution.	-	The memory card does not have enough speed to record.	<ul style="list-style-type: none"> Record movie at a lower resolution. Change the memory card to a faster one. ▶ page 40

Recording

Message	Icon	Informs that...	Action
Write Error	-	Some problems occurred while writing data to storage media.	<ul style="list-style-type: none"> Format storage media using menus after backing-up important files to your PC or another storage media.
Release the EASY Q	-	You cannot operate some functions manually when EASY Q is activated.	<ul style="list-style-type: none"> Release EASY Q function.

troubleshooting

Playback

Message	Icon	Informs that...	Action
Read Error	-	Some problems occurred during reading data from storage media.	<ul style="list-style-type: none">Format storage media using menus after backing up important files to PC or another storage device.
The Number of video files is full. Cannot copy videos.	-	Folder and files have reached capacity and you can not record.	<ul style="list-style-type: none">Format the storage media using the menu after backing up important files to your PC or another storage device. Set "File No." to "Reset."
The Number of photo files is full. Cannot copy photos. (SMX-C13/C14 only)	-	Folder and files have reached their capacity and you cannot take a picture.	<ul style="list-style-type: none">Format storage media using the menu item after backing up important files to your PC or another storage device. Set "File No." to "Reset."



CAUTION

When there is condensation, put aside for a while before using

- What is condensation?
Condensation occurs when a camcorder is moved to a place where the temperature differs significantly from the previous place. In other words, the water vapor in the air turns into dew because of the temperature difference, and it condensates like dew on the external or internal lenses of the camcorder and on the reflection lens. When this happens, you temporarily may not use the record or play functions of the camcorder. Also, it may cause a malfunction or damage to the camcorder when using the device with the power on while there is condensation.
- What can I do?
Turn the power off and detach the battery pack, and leave it in a dry area for 1~2 hours before using it.
- When does condensation occur?
When the device is relocated to a place with a higher temperature than the previous location, or when using it in a hot area suddenly.
 - When recording outdoors in cold weather during the winter and then using it in indoors.
 - When recording outdoors in hot weather after being indoors or inside a car where the air conditioner was running.

Note before sending your camcorder for repair.

- If these instructions do not solve your problem, contact your nearest Samsung authorised service center.
- Depending on the problem, the camcorder's built-in memory (SMX-C13/SMX-C14 only) may need to be initialized or replaced and the data will be deleted. Be sure to back up the data on the camcorder to other storage media before sending your camcorder in for repair. Samsung cannot guarantee any loss of your data.

- ⚠ If you encounter any problems using your camcorder, check the following before asking for service repair. If these instructions do not solve your problem, contact the nearest Samsung authorised service center.

Symptoms and solutions

Power

Symptom	Explanation/Solution
The camcorder does not turn on.	<ul style="list-style-type: none"> The battery pack may not be installed on your camcorder. Insert a battery pack into the camcorder. The inserted battery pack may be discharged. Charge the battery pack or replace it with a charged one. If you use an AC power adaptor, make sure it is properly connected to the wall outlet. Remove the battery pack or unplug the AC power adaptor, and reconnect the power supply to the camcorder before turning it on.
The power automatically turns off.	<ul style="list-style-type: none"> Is "Auto Power Off" set to "5 Min"? If no button is pressed for about 5 minutes, the camcorder is automatically turned off ("Auto Power Off"). To disable this option, change the setting of "Auto Power Off" to "Off" ➔page 93 The battery pack is almost discharged. Charge the battery pack or replace it with a charged one. Use the AC power adaptor.
Power cannot be turned off .	<ul style="list-style-type: none"> Remove the battery pack or unplug the AC power adaptor, and reconnect the power supply to the camcorder before turning it on.
The battery pack is quickly discharged.	<ul style="list-style-type: none"> The temperature is too low. The battery pack is not fully charged. Recharge the battery pack. The battery pack reached the end of its lifespan and cannot be recharged. Use another battery pack.

troubleshooting

Displays

Symptom	Explanation/Solution
The Recorded Image is more narrow or fat than original image.	<ul style="list-style-type: none">You should check the resolution before you record. ➡page 58
Unknown image appears on the LCD screen.	<ul style="list-style-type: none">The camcorder is in Demo mode. If you do not want to see Demo images, change the setting of "Demo" to "Off." ➡page 95
Unknown indicator appears on the screen.	<ul style="list-style-type: none">A warning indicator or message appears on the screen. ➡pages 114~116
The after image remains on the LCD screen.	<ul style="list-style-type: none">This occurs if you disconnect the AC power adaptor or remove the battery pack before turning the power off.
The image on the LCD screen looks dark.	<ul style="list-style-type: none">Ambient light is too bright. Adjust the brightness and angle of the LCD.Use the LCD Enhancer function.

Storage Media

Symptom	Explanation/Solution
Memory card functions are not operable.	<ul style="list-style-type: none">• Insert a memory card into your camcorder properly. ➡page 39• If you use a memory card formatted on a computer, format it again directly on your camcorder. ➡page 87
Image cannot be deleted.	<ul style="list-style-type: none">• You cannot delete the images protected by another device. Release the protection of the image on the device. ➡page 74• Release the lock on the write-protect tab of the memory card (SDHC memory card, etc.), if any. ➡page 40
You cannot format the memory card.	<ul style="list-style-type: none">• Release the lock on the write-protect tab of the memory card (SDHC memory card, etc.), if any. ➡page 40• Copy all important recorded files to your PC before formatting. Samsung shall not be responsible for any loss of data. (It is recommended that you copy the data to your PC or other storage media.)
The data file name is not indicated correctly.	<ul style="list-style-type: none">• The file may be corrupted.• The file format is not supported by your camcorder.• Only the file name is displayed, if the directory structure does not comply with the international standard.
Does not charge or operate even if the battery pack is inserted.	<ul style="list-style-type: none">• Check whether you're using a Samsung battery pack. A non-Samsung battery pack may not be recognised properly by the camcorder.

troubleshooting

Recording

Symptom	Explanation/Solution
Pressing the Recording start/stop button does not start recording.	<ul style="list-style-type: none">• There is not enough free space to record on the the storage media.• Make sure the memory card is inserted and write-protect tab is set to unlock.• The internal temperature of your camcorder is unusually high. Turn off your camcorder and leave it for a while in a cool place.• Your camcorder is damp and moist inside (condensation). Turn off your camcorder and leave it for about 1 hour in a cool place.
The actual recording time is less than the estimated time.	<ul style="list-style-type: none">• The estimated recording time may vary depending on contents and features used.• Recording a fast-moving subject increases the bit rate and consequently the amount of storage space required for the recording, which can lead to a shorter available recording time.
The recording stops automatically.	<ul style="list-style-type: none">• There is no more free space for recording on the storage media. Back up important files on your PC and format the storage media or delete the unnecessary files.• If you frequently record or delete files, the performance of the built-in flash memory will deteriorate. In this case, reformat the built-in memory.• If you use a memory card with a low writing speed, the camcorder automatically stops recording the movie images and the corresponding message appears on the LCD screen.
When recording a subject illuminated by bright light, vertical lines appear.	<ul style="list-style-type: none">• The camcorder is unable to record these levels of brightness.

Recording

Symptom	Explanation/Solution
When the screen is exposed to direct sunlight during recording, the screen turns red or black for an instant.	<ul style="list-style-type: none"> Do not leave the camcorder with the LCD screen exposed to direct sunlight.
During recording, the date/time does not display.	<ul style="list-style-type: none"> "Date/Time" is set to off. Set the "Date/Time" to on. ➡page 35
The beep sound is not heard.	<ul style="list-style-type: none"> Set the "Beep Sound" to "On." The beep sound is temporarily off while recording movies. When the Audio/Video cable jack is connected to the camcorder, the beep sound will automatically turn off.
There is a time difference between the point where you press Recording start/stop button and the point where the recorded movie starts/stops.	<ul style="list-style-type: none"> On your camcorder, there may be a slight time delay between the point when you press Recording start/stop button and the actual point where the recorded movie starts/stops. This is not an error.
The recording stops.	<ul style="list-style-type: none"> The internal temperature of your camcorder is unusually high. Turn off your camcorder and leave it for a while in a cool place. Your camcorder is damp and moist inside (condensation). Turn off your camcorder and leave it for about 1 hour in a cool place.
You cannot record a photo image. (SMX-C13/C14 only)	<ul style="list-style-type: none"> Set your camcorder to Record mode. ➡page 24 Release the lock on the write-protection tab of the memory card if set. The storage media is full. Use a new memory card or format the storage media. ➡page 87 Or remove unnecessary images. ➡page 73

troubleshooting

Adjusting the image during recording

Symptom	Explanation/Solution
Focus does not adjust automatically.	<ul style="list-style-type: none">• Set "Focus" to "Auto." ➔page 62• The recording conditions are not suitable for auto focus. Adjust the focus manually. ➔page 62• The lens is dusty on the surface. Clear the lens and check the focus.• Recording is being made in a dark place. Increase the brightness in the place.
The image appears too bright or flickering, or changes in color.	<ul style="list-style-type: none">• This occurs when recording images under a fluorescent lamp, sodium lamp, or mercury lamp. Cancel "iSCENE" to minimise these phenomena. ➔page 57

Playback on your camcorder

Symptom	Explanation/Solution
Pressing the playback (Play/Pause) button did not start playing.	<ul style="list-style-type: none">• Press the Mode (Ⓢ) button to set Movie Play mode.• Image files recorded on another camcorder may not play on your camcorder.• Check out the memory card compatibility. ➡page 40
The Skip or Search function does not work properly.	<ul style="list-style-type: none">• If the temperature inside the camcorder is too high, it cannot function properly. Turn the camcorder off, wait for a few moments, and turn it on again.
Playback is interrupted unexpectedly.	<ul style="list-style-type: none">• Check if the AC adaptor or battery pack is properly connected and stable.
You cannot hear sound when playing a Time Lapse recording.	<ul style="list-style-type: none">• The Time Lapse REC function does not support sound. ➡page 68
Photo images stored on a storage media are not displayed in the actual size. (SMX-C13/C14 only)	<ul style="list-style-type: none">• Photo images recorded on other devices may not appear at actual size. This is not an error.

Playback on other devices (TV, etc.)

Symptom	Explanation/Solution
You cannot view the image or hear the sound on the connected device.	<ul style="list-style-type: none">• Connect the audio line of the Audio/Video cable jack to your camcorder and the connected device (TV, DVD recorder, etc). (Red color- right, White color- left)• The Audio/Video cable jack is not connected properly. Make sure that the Audio/Video cable jack is connected to the proper jack. ➡page 107, 109
The image appears distorted on TV or PC Player.	<ul style="list-style-type: none">• The display mode of the recorded video does not match that of playback device.• A video recorded in 16:9 wide mode should be played back on a TV or PC that supports 16:9 screen mode.

troubleshooting

Connecting to a computer

Symptom	Explanation/Solution
When using the movies, a computer does not recognize your camcorder.	<ul style="list-style-type: none">• Disconnect the USB cable from the computer and camcorder, restart the computer, then reconnect it correctly.
Cannot play a movie file properly on a PC.	<ul style="list-style-type: none">• A video codec is needed to play the file recorded on your camcorder. Install or run the built-in edit software (Intelli-studio).• Make sure you insert the connector in the correct direction, and connect the USB cable to the USB jack on your camcorder firmly.• Disconnect the cable from the computer and camcorder, restart the computer. Reconnect it properly.• Your computer may not have the necessary performance specifications to playback a video file. Check the recommended computer specifications.
Intelli-studio does not function properly.	<ul style="list-style-type: none">• Exit the Intelli-studio application, and restart the Windows computer.• Intelli-studio is not Macintosh compliant.• Set "PC Software" to "On" in the Settings menu.• According to your computer type, the Intelli-studio program may not run automatically. In this case, open the desired CD-ROM drive that has the Intelli-studio program in My Computer and run iStudio.exe.
The image or sound on your camcorder is not played on your computer properly.	<ul style="list-style-type: none">• Movie playback or sound may stop temporarily depending on your computer. The movie or sound copied to your computer is not affected.• If your camcorder is connected to a computer that does not support Hi-speed USB (USB2.0), the images or sound may not be played back correctly. The images and sound copied to your computer are not affected.
The playback screen is paused or distorted.	<ul style="list-style-type: none">• Check the system requirements to play a movie. ➔page 97• Exit all other applications running on the current computer.• If a recorded movie is played on your camcorder when it is connected to a computer, the image may not play smoothly, depending on the transfer speed. Please copy the file to your PC, and then play it back.

Connecting/Dubbing with other devices (TV, DVD recorder, etc.)

Symptom	Explanation/Solution
You cannot dub correctly using the Audio/Video cable.	<ul style="list-style-type: none">The Audio/Video cable is not connected properly. Make sure that the Audio/Video cable is connected to the proper jack, i.e. to the input jack of the device used for dubbing an image from your camcorder. ➡page 107, 109

General operations

Symptom	Explanation/Solution
The date and time are incorrect.	<ul style="list-style-type: none">Has the camcorder been left unused for a long period of time? The backup built-in rechargeable battery may be discharged. ➡page 36
Pressing a button will not turn on or operate the computer.	<ul style="list-style-type: none">Remove the battery pack or unplug the AC power adaptor, and reconnect the power supply to the camcorder before turning it on.

troubleshooting

Menu

Symptom	Explanation/Solution																
Menu items are grayed out.	<ul style="list-style-type: none"> You cannot select grayed items in the current recording/playback mode. Most of the menu items cannot be selected when you set the EASY Q function. If there is no storage media inserted, it cannot be selected and will be dimmed on the menu : "Storage", "Storage Info", "Format", etc. There are some functions you cannot activate simultaneously. The following list shows examples of unworkable combinations of functions and menu items. If you want to set the desired functions, do not set the following items first. 																
	<table border="1"> <thead> <tr> <th><Cannot Use></th> <th><Because of the following setting></th> </tr> </thead> <tbody> <tr> <td>"Digital Zoom"</td> <td>"Anti-Shake (HDIS)", "Digital Effect : Mirror, Mosaic, Step printing", "Video Resolution: Web Fine, Web Normal"</td> </tr> <tr> <td>"Digital Effect : Mirror, Mosaic, Step printing"</td> <td>"Anti-Shake (HDIS)", "iSCENE: Night, Darkness", "16:9 Wide"</td> </tr> <tr> <td>"Focus : Face Detection"</td> <td>"iSCENE: Night, Darkness", "Digital Effect", "Video Resolution: Web Fine, Web Normal"</td> </tr> <tr> <td>"Fader"</td> <td>"Time Lapse REC"</td> </tr> <tr> <td>"EASY Q"</td> <td>"Video Resolution: Web Fine, Web Normal"</td> </tr> <tr> <td>"16:9 Wide"</td> <td>"Video Resolution: Web Fine, Web Normal"</td> </tr> <tr> <td>"Anti-Shake (HDIS)"</td> <td>"Video Resolution: Web Fine, Web Normal"</td> </tr> </tbody> </table>	<Cannot Use>	<Because of the following setting>	"Digital Zoom"	"Anti-Shake (HDIS)", "Digital Effect : Mirror, Mosaic, Step printing", "Video Resolution: Web Fine, Web Normal"	"Digital Effect : Mirror, Mosaic, Step printing"	"Anti-Shake (HDIS)", "iSCENE: Night, Darkness", "16:9 Wide"	"Focus : Face Detection"	"iSCENE: Night, Darkness", "Digital Effect", "Video Resolution: Web Fine, Web Normal"	"Fader"	"Time Lapse REC"	"EASY Q"	"Video Resolution: Web Fine, Web Normal"	"16:9 Wide"	"Video Resolution: Web Fine, Web Normal"	"Anti-Shake (HDIS)"	"Video Resolution: Web Fine, Web Normal"
	<Cannot Use>	<Because of the following setting>															
	"Digital Zoom"	"Anti-Shake (HDIS)", "Digital Effect : Mirror, Mosaic, Step printing", "Video Resolution: Web Fine, Web Normal"															
	"Digital Effect : Mirror, Mosaic, Step printing"	"Anti-Shake (HDIS)", "iSCENE: Night, Darkness", "16:9 Wide"															
	"Focus : Face Detection"	"iSCENE: Night, Darkness", "Digital Effect", "Video Resolution: Web Fine, Web Normal"															
	"Fader"	"Time Lapse REC"															
	"EASY Q"	"Video Resolution: Web Fine, Web Normal"															
	"16:9 Wide"	"Video Resolution: Web Fine, Web Normal"															
	"Anti-Shake (HDIS)"	"Video Resolution: Web Fine, Web Normal"															
<ul style="list-style-type: none"> The following list shows examples of some functions you cannot activate when the camcorder is in a specific mode. If you want to set the desired function, change the mode first. 																	
<table border="1"> <thead> <tr> <th><Cannot Use></th> <th><If the camcorder is in the following mode:></th> </tr> </thead> <tbody> <tr> <td>"LCD Brightness", "LCD Color", "Transparency", "Demo"</td> <td>"Play mode": Thumbnail index screen or full image display mode of movie (or photo) images</td> </tr> <tr> <td>"TV Display"</td> <td>"Play mode": Thumbnail index screen of movie (or photo) images</td> </tr> <tr> <td>"Storage", "Auto Power Off", "Default Set"</td> <td>"Play mode": Full image display mode of movie (or photo) images</td> </tr> <tr> <td>"Beep Sound"</td> <td>"Play mode": Full image display mode of movie images</td> </tr> </tbody> </table>	<Cannot Use>	<If the camcorder is in the following mode:>	"LCD Brightness", "LCD Color", "Transparency", "Demo"	"Play mode": Thumbnail index screen or full image display mode of movie (or photo) images	"TV Display"	"Play mode": Thumbnail index screen of movie (or photo) images	"Storage", "Auto Power Off", "Default Set"	"Play mode": Full image display mode of movie (or photo) images	"Beep Sound"	"Play mode": Full image display mode of movie images							
<Cannot Use>	<If the camcorder is in the following mode:>																
"LCD Brightness", "LCD Color", "Transparency", "Demo"	"Play mode": Thumbnail index screen or full image display mode of movie (or photo) images																
"TV Display"	"Play mode": Thumbnail index screen of movie (or photo) images																
"Storage", "Auto Power Off", "Default Set"	"Play mode": Full image display mode of movie (or photo) images																
"Beep Sound"	"Play mode": Full image display mode of movie images																

specifications

**Model Name: SMX-C10RN/SMX-C10LN/SMX-C10GN/SMX-C13RN/SMX-C13LN/SMX-C13GN/
SMX-C14RN/SMX-C14LN/SMX-C14GN/SMX-C100RN/SMX-C100LN/SMX-C100GN**

System	
Video signal	NTSC
Picture compression format	H.264/AVC Format
Audio compression format	AAC (Advanced Audio Coding)
Recording resolution	TV Super Fine (about 5.0Mbps), TV Fine (about 4.0Mbps), TV Normal (about 3.0Mbps), Web Fine (about 4.0Mbps), Web Normal (about 3.0Mbps)
Image device	CCD (Charge Coupled Device) (Max: 680K pixels)
Lens	F1.8 to 2.4, 10x (Optical), 1200x (Digital) Electronic zoom lens
Focal Length	2.4mm~24mm
LCD screen	
Size/dot number	2.7 inches wide, 230k
LCD screen method	1.6" interlaced scan, LCD panel / TFT active matrix system
Connectors	
Composite video out	1.0V (p_p), 75 Ω , analog
Audio output	(-7.5dBm 47K Ω , analog, stereo)
USB output	mini USB-B type (USB2.0 High Speed)
General	
Power source	5.0V (Using AC adaptor), 3.7V (Using Lithium Ion battery pack)
Power source type	Power supply (100V~240V) 50/60Hz, Lithium Ion battery pack
Power consumption	1.8W (LCD on)
Operating temperature	32°F~104°F (0°~40°C)
Operating humidity	10% ~80%
Storage temperature	-4°F ~ 140°F (-20°C ~ 60°C)
Dimensions (W x H x D)	Approx. 1.5" x 2.22" x 4.48" (38.5mm x 56.5mm x 114mm)
Weight	Approx. 0.34lbs (156g) (without battery pack or memory card)
Internal MIC	Omni-directional stereo microphone

- These technical specifications and design may be changed without notice.

warranty

SAMSUNG LIMITED WARRANTY

SAMSUNG Electronics America Inc. (SEA), warrants that this product is free from defective material and workmanship.

SEA further warrants that if product fails to operate properly within the specified warranty period and the failure is due to improper workmanship or defective material, SEA will repair or replace the product at it's option.

All warranty repairs must be performed by a SEA authorized service center. The name and address of the location nearest you can be obtained by calling toll free: 1-800 SAMSUNG (1-800-726-7864).

Labor

90 days carry-in

Parts

1 year

On carry-in models, transportation to and from the service center is the customer's responsibility.

The original dated sales receipt must be retained by the customer and is the only acceptable proof of purchase. It must be presented to the authorized service center.

EXCLUSIONS (WHAT IS NOT COVERED)

This warranty does not cover damage due to accident, fire, flood and/or other acts of God; misuse, incorrect line voltage, improper installation, improper or unauthorized repairs, commercial use, or damage that occurs in shipping. Exterior and interior finish, lamps, and glass are not covered under this warranty.

Customer adjustments which are explained in the instruction manual are not covered under the terms of this warranty.

This warranty will automatically be voided for any unit found with a missing or altered serial number. This warranty is valid only on products purchased in the United States and Puerto Rico.

Some States do not allow the exclusions or limitations of incidental or consequential damages, or allow limitations on how long an implied warranty lasts, so the above limitations or exclusions may not apply to you.

This warranty gives you specific legal rights, and you may also have other rights which vary from State to State.



If you have any questions or comments relating to Samsung products, please contact the SAMSUNG customer care center Samsung Electronics America, inc.

1-800-SAMSUNG (726-7864)

www.samsung.com/us



RoHS compliant

Our product complies with "The Restriction Of the use of certain Hazardous Substances in electrical and electronic equipment", and we do not use the 6 hazardous materials- Cadmium(Cd), Lead (Pb), Mercury (Hg), Hexavalent Chromium (Cr +6), Poly Brominated Biphenyls (PBBs), Poly Brominated Diphenyl Ethers(PBDEs)- in our products.